

Input Port

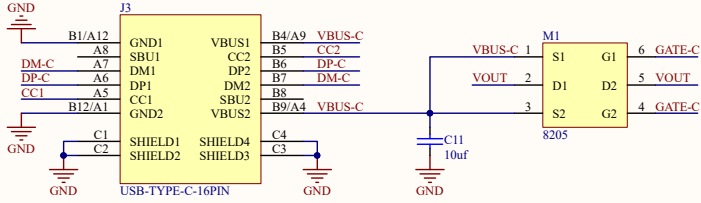

Battery Port

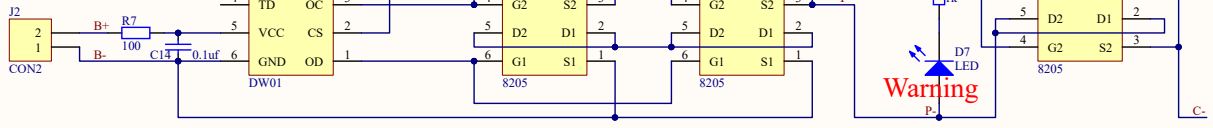

Input Port

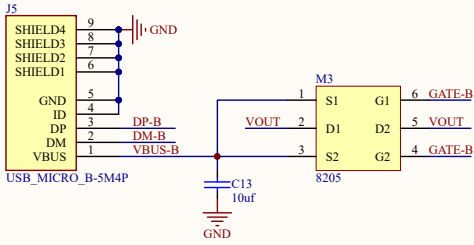

# Li-ion Battery HAT

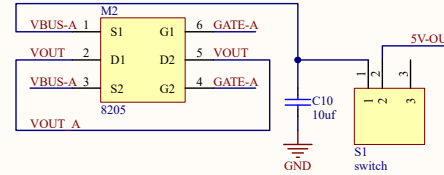

Output Port

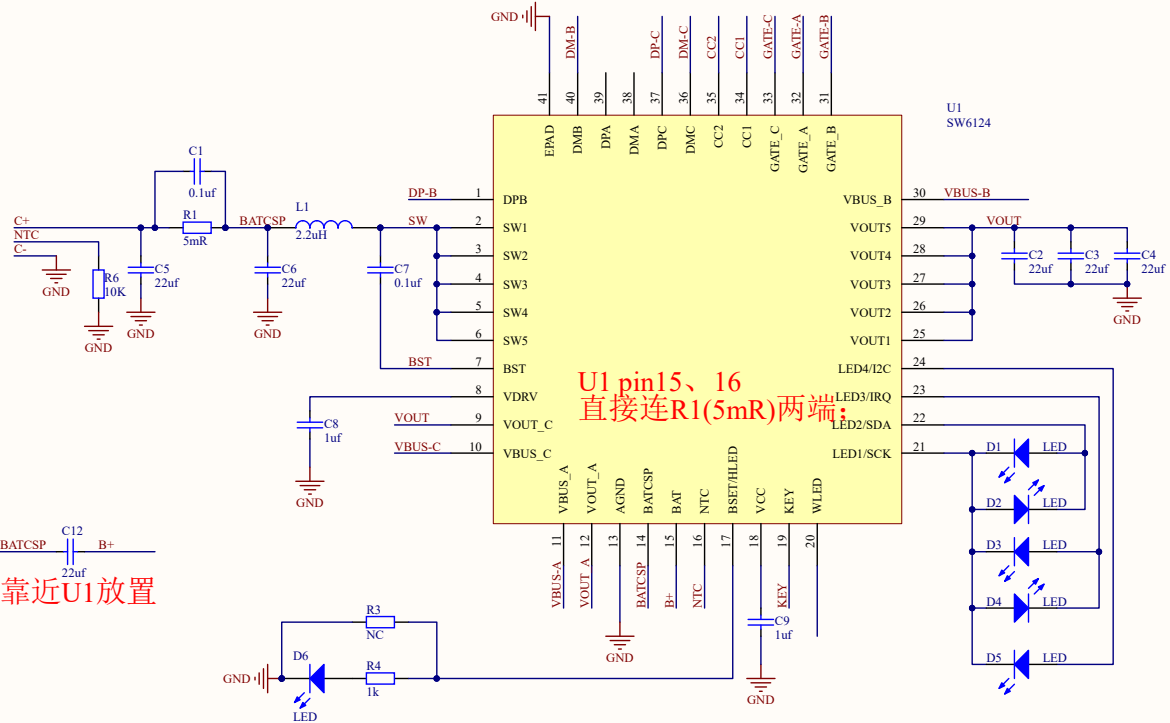
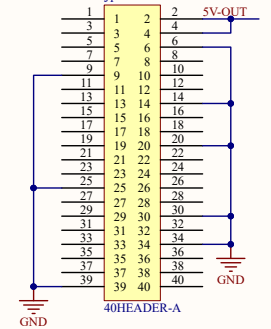

U1 pin15、16 直接连R1(5mR)两端;

靠近U1放置

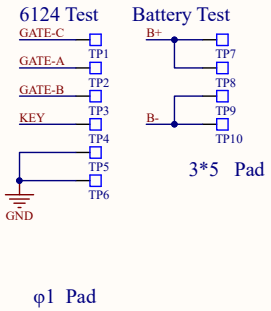
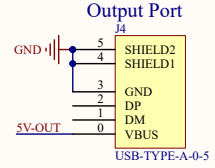

Title		
Size	Number	Revision
A3		
Date:	2018/7/20	Sheet of
File:	C:\Users\...\PiBattery-B.SchDoc	Drawn By: