

BS	VCC	GND
Interface	3-line SPI	4-line SPI

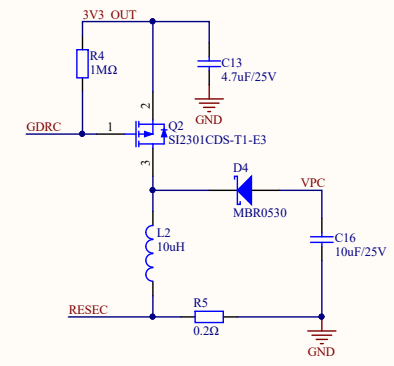

Type	BS1	BS0	SPI mode
1	0	0	4-wire SPI
2	0	1	3-wire SPI
3	1	0	Standard 4-wire SPI/Dual SPI/Quad SPI
4	1	1	Standard 4-wire SPI/Dual SPI/Quad SPI

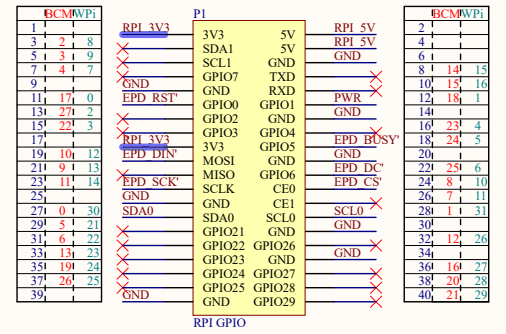

VCC INT RPI 5V

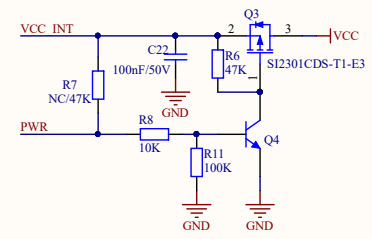
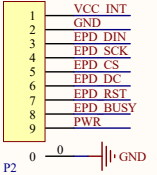

Introduction to R4 resistors :
 * NC : Use a separate pin control, in order to save electricity
 * 47K : Always powered on, saving I/O interfaces

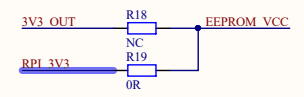
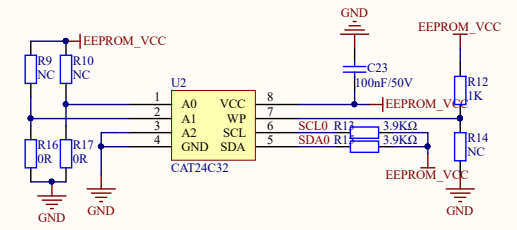
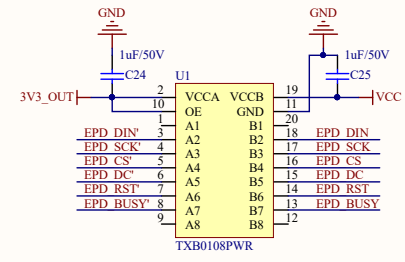
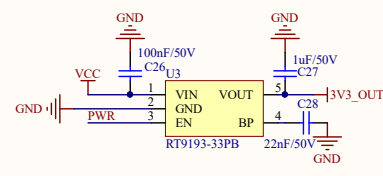

W aveshare HAT+
 4inch e-Paper HAT+

BS	Interface
1	3-line SPI
0	4-line SPI



PWR
BUSY
RST
DC
CS
CLK
DIN
GND
VCC

BS

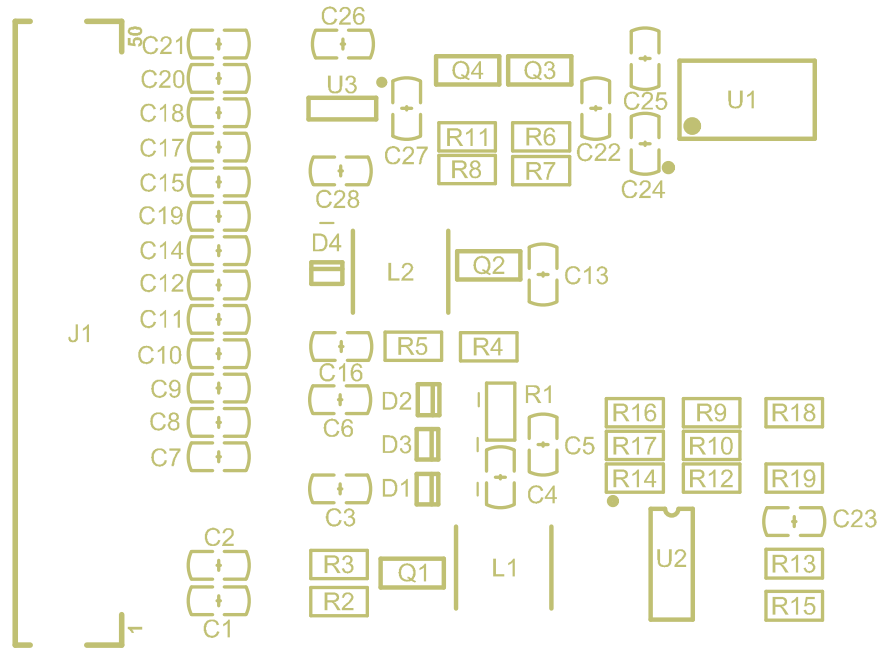

4inch e-Paper HAT+

600x400 Pixels

HAT+

