

MIPI

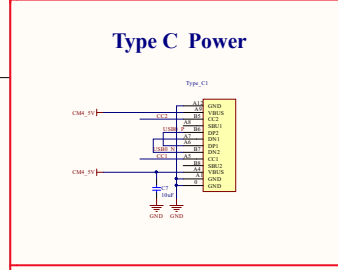

Type C Power

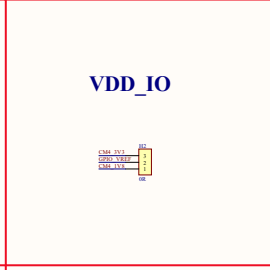

VDD\_IO

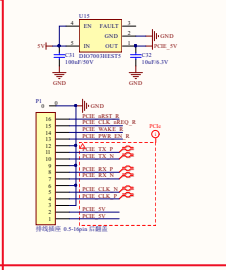

KEY

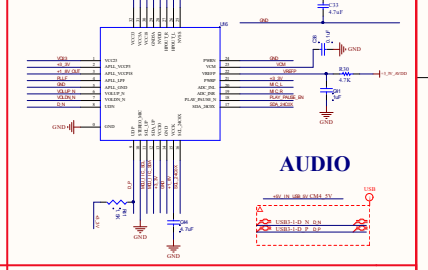

AUDIO

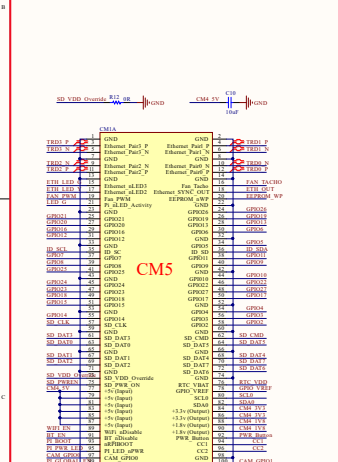

LED

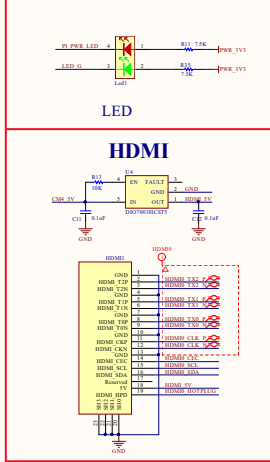

HDMI

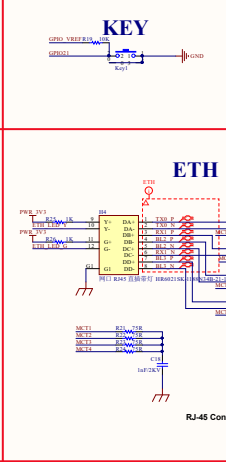

ETH

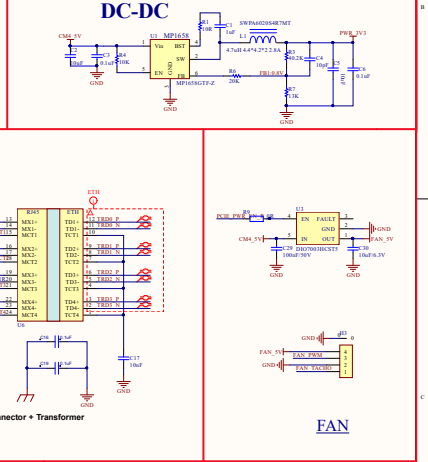

DC-DC

FAN

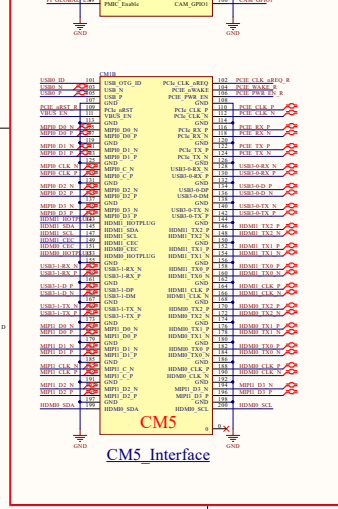

CMS Interface

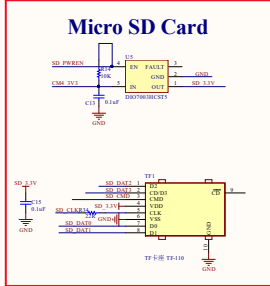

Micro SD Card

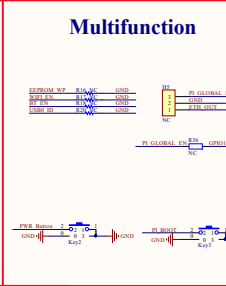

Multifunction

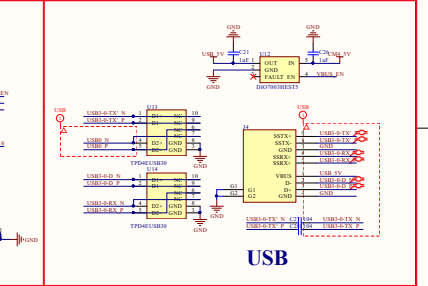

USB

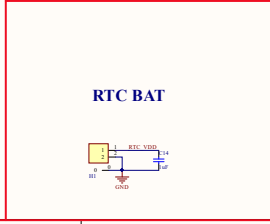

RTC BAT



LOGO



CMS-NANO-B

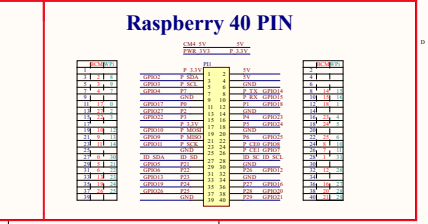

Raspberry 40 PIN

PIN	NAME	FUNCTION	TYPE
1	GND	Ground	GND
2	VCC	3.3V	VCC
3	GND	Ground	GND
4	VCC	3.3V	VCC
5	GND	Ground	GND
6	VCC	3.3V	VCC
7	GND	Ground	GND
8	VCC	3.3V	VCC
9	GND	Ground	GND
10	VCC	3.3V	VCC
11	GND	Ground	GND
12	VCC	3.3V	VCC
13	GND	Ground	GND
14	VCC	3.3V	VCC
15	GND	Ground	GND
16	VCC	3.3V	VCC
17	GND	Ground	GND
18	VCC	3.3V	VCC
19	GND	Ground	GND
20	VCC	3.3V	VCC
21	GND	Ground	GND
22	VCC	3.3V	VCC
23	GND	Ground	GND
24	VCC	3.3V	VCC
25	GND	Ground	GND
26	VCC	3.3V	VCC
27	GND	Ground	GND
28	VCC	3.3V	VCC
29	GND	Ground	GND
30	VCC	3.3V	VCC
31	GND	Ground	GND
32	VCC	3.3V	VCC
33	GND	Ground	GND
34	VCC	3.3V	VCC
35	GND	Ground	GND
36	VCC	3.3V	VCC
37	GND	Ground	GND
38	VCC	3.3V	VCC
39	GND	Ground	GND
40	VCC	3.3V	VCC