

TFT LCD MODULE

1.47 inch 172RGB*320DOTS

MODULE NUMBER: **LBS147TC-IF15**

REVISION: **A**

Customer:
Approved by

Approved by

Revised History

Part Number	Revision	Revision Content	Revised on
LBS147TC-IF15	A	New	2021-11-23

Contents

Revision History

Contents

- 1. *General Description***
- 2. *Mechanical Drawing***
- 3. *Pin Description***
- 4. *Electrical Characteristics***
- 5. *Optical Characteristics***
- 6. *Reliability***
- 7. *Package Specifications***
- 8. *Incoming Inspection standards***
- 9. *Precautions When Using These TFT Display Modules***
- 10. *Warranty***
- 11. *Notice***

1. General Description

1.1 Description

LBS147TC-IF15 is a 172RGBX320 dot-matrix TFT LCD module. This module is composed of a TFT LCD Panel, driver ICs, FPC and a Backlight unit.

1.2 Features

NO.	Item	Contents	Unit
1	LCD Size	1.47	inch
2	Display Mode	Normally black	-
3	Resolution	172(H)RGB x320(V)	pixels
4	Pixel pitch	0.0337(H) x 0.1011(V)	mm
5	Active area	17.3892(H) x 32.352(V)	mm
6	Module size	19.39(H) x 36.28(V) x1.46 (D)	mm
7	Pixel arrangement	RGB Vertical stripe	-
8	Interface	4 Line SPI	-
9	Display Colors	262K	colors
10	Drive IC	ST7789V3	-
11	Luminance(cd/m ²)	350 (TYP)	Cd/m ²
12	Viewing Direction	All View	Best image
13	Backlight	2 White LED Parallel	-
14	Operating Temp.	-20°C~ + 70°C	°C
15	Storage Temp.	-30°C~+ 80°C	°C
16	Weight	2.7	g

2. Mechanical Drawing

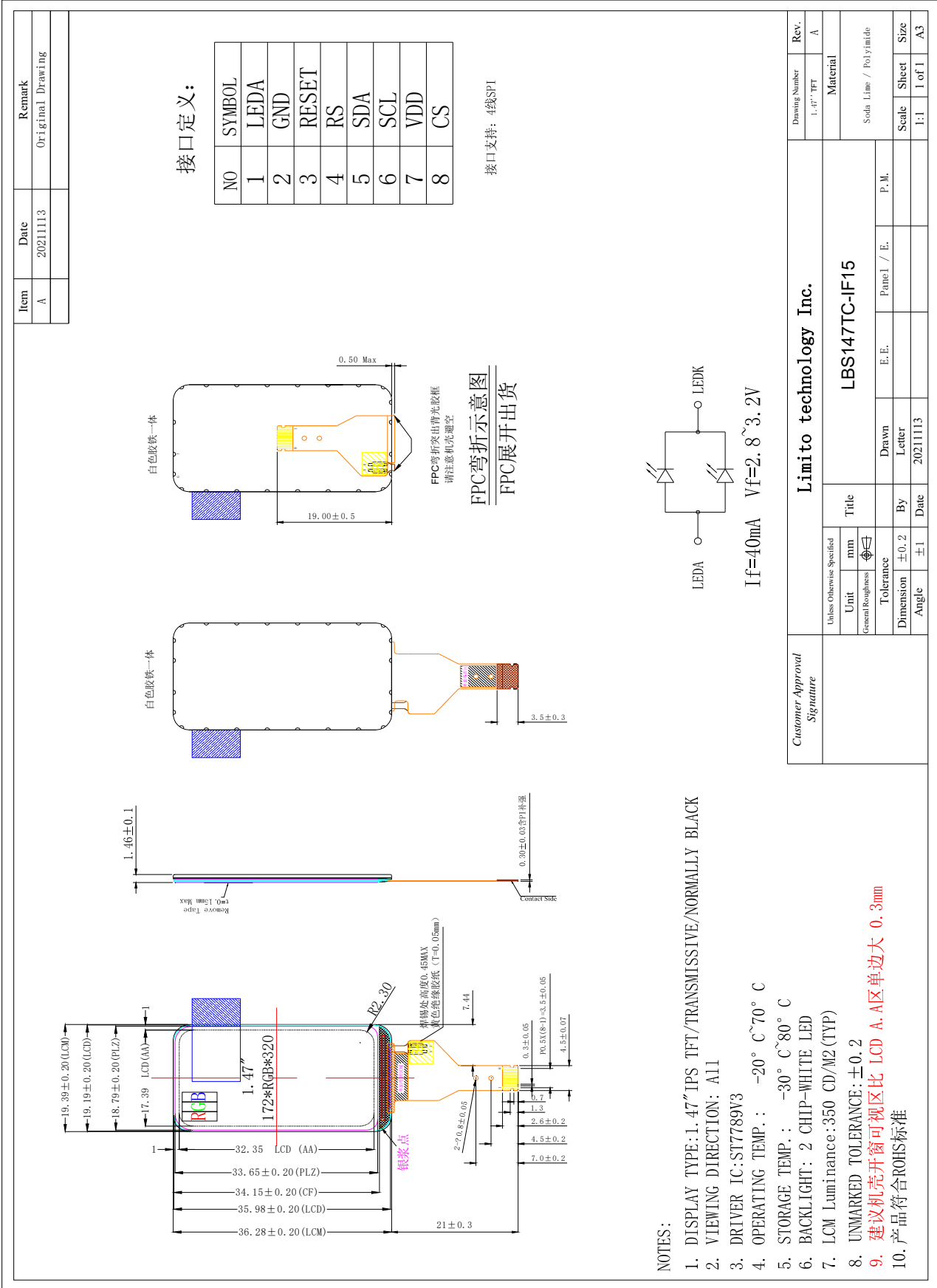

3. Pin Definition

FPC Connector is used for the module electronics interface.

NO.	Symbol	Description
1	LEDA	LED Anode
2	GND	Power Ground.
3	RESET	This signal will reset the device ,Signal is active low.
4	RS	Display data/command selection pin in 4-line serial interface.
5	SDA	SPI interface input/output pin.
6	SCL	This pin is used to be serial interface clock.
7	VDD	Power Supply for Analog
8	CS	Chip selection pin ,Low enable ,High disable.

Note:

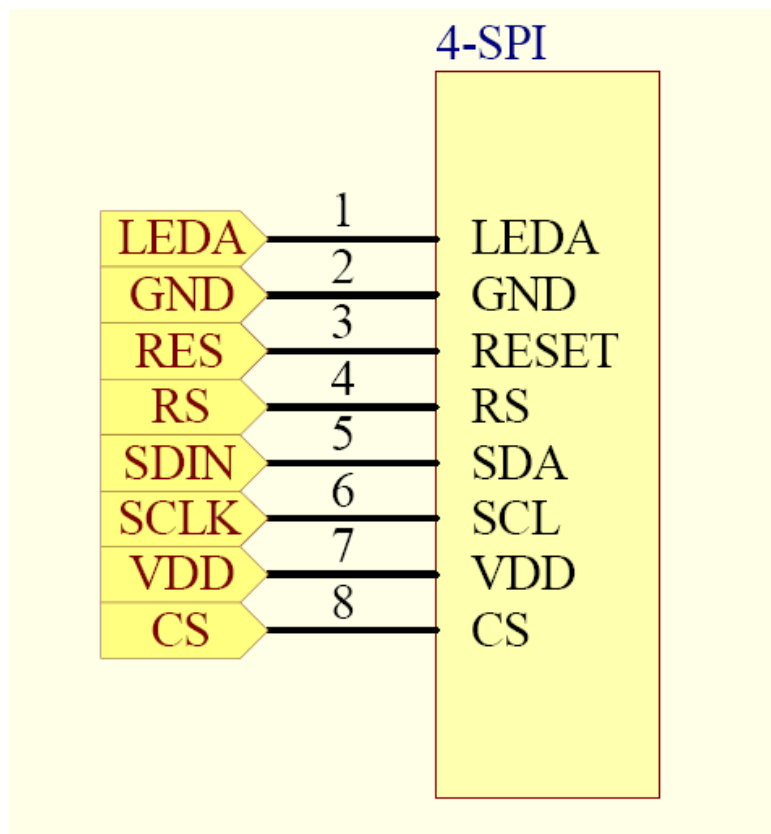

4. Electrical Characteristics

4.1 Absolute Maximum Ratings

Parameter	Symbol	Min	MAX	Unit	Notes
Supply Voltage (I/O)	VDD	-0.3	4.6	V	
Analog Supply Voltage	VDDIO	-0.3	4.6	V	
Logic Input Voltage	VIN	-0.3	VDDIO+0.5	V	
Operation Temperature	Top	-20	70	°C	
Storage Temperature	Tst	-30	80	°C	

4.2 Operating Conditions

Parameter	Symbol	Min	TYP	MAX	Unit	Notes
System Voltage	VDD	2.5	2.8	3.3	V	
Interface Operation Voltage	VDDIO	1.65	1.8	3.3	V	
Gate Driver High Voltage	VGH	12.2	-	14.97	V	
Gate Driver Low Voltage	VGL	-12.5	-	-7.16	V	
Operating Current for V _{DD}	I _{DD}	-	8	10	mA	
Sleep_In Mode VDD	I _{dd}	-	15	30	uA	
Sleep_In Mode VDDIO	I _{ddio}	-	5	10	uA	

4.3 Backlight Unit

Parameter	Symbol	Min	TYP	MAX	Unit	Notes
Voltage for LED backlight	VLED	2.8	3.0	3.2	V	
Current for LED backlight	ILED	-	40	60	mA	2 LED
Power Consumption	Pbl	-	120	192	mW	1
Brightness	L _{br}	300	350	-	cd/m ²	2
LED Life time	-	20000	-	-	hr	3

Note:

1. Where ILED =40mA , VLED=3.0V , Pbl= ILED x VLED
2. Uniform measure condition:
 - a: Measure 9 point ,Measure location is show below:
 - b: Uniform=(Min brightness/Max brightness)x100%
 - c: Best Contrast.

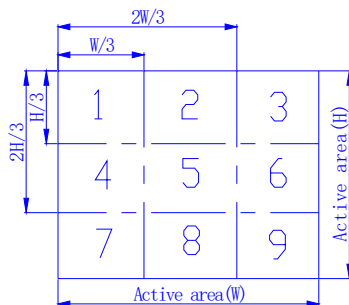

3. The environmental conducted under ambient air flow ,at Ta=25±2°C,60%RH±5%

4.4 Backlight Recommended Circuit

Motherboard driver backlight is need constant current circuit , if threated voltage screen after light brightness difference . Current and power consumption of the machine are inconsistent , so recommend a backlight driving circuit is best rated current . It is recommended to use IC (AW9364) . The reference circuit is as follows:

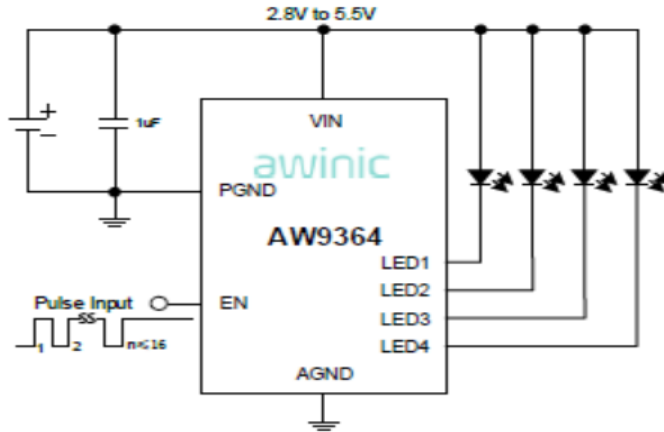

4.5 AC Timing Characteristic of The LCD

Serial interface Characteristics(4-line serial):

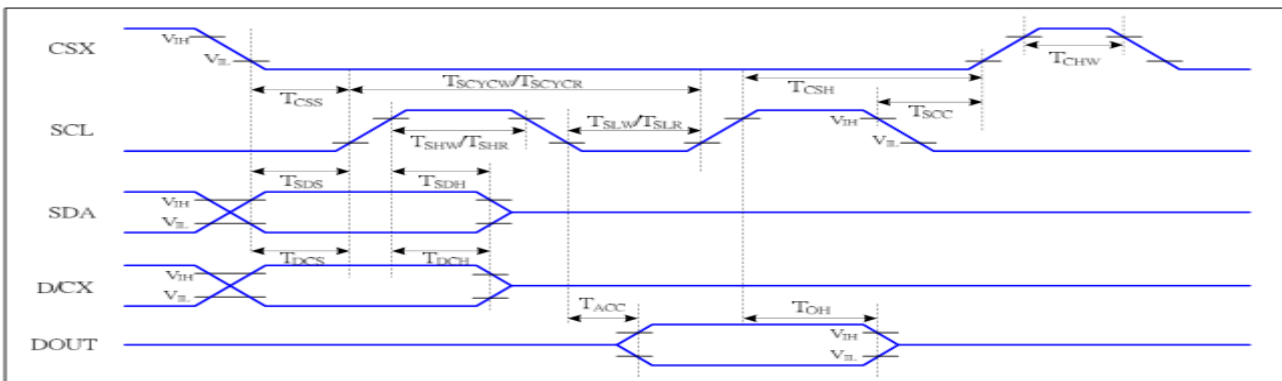

Signal	Symbol	Parameter	MIN	MAX	Unit	Description
CSX	T_{CSS}	Chip select setup time (write)	15		ns	
	T_{CSH}	Chip select hold time (write)	15		ns	
	T_{CSS}	Chip select setup time (read)	60		ns	
	T_{SCC}	Chip select hold time (read)	65		ns	
	T_{CHW}	Chip select "H" pulse width	40		ns	
SCL	T_{SCYCW}	Serial clock cycle (Write)	16		ns	-write command & data ram
	T_{SHW}	SCL "H" pulse width (Write)	7		ns	
	T_{SLW}	SCL "L" pulse width (Write)	7		ns	
	T_{SCYCR}	Serial clock cycle (Read)	150		ns	-read command & data ram
	T_{SHR}	SCL "H" pulse width (Read)	60		ns	
	T_{SLR}	SCL "L" pulse width (Read)	60		ns	
D/CX	T_{DCS}	D/CX setup time	10		ns	
	T_{DCH}	D/CX hold time	10		ns	
SDA (DIN)	T_{SDS}	Data setup time	7		ns	
	T_{SDH}	Data hold time	7		ns	
DOUT	T_{ACC}	Access time	10	50	ns	For maximum $CL=30pF$
	T_{OH}	Output disable time	15	50	ns	For minimum $CL=8pF$

5. OPTICAL CHARACTERISTICS

Item	Symbol	Measuring Conditions		Min.	Typ.	Max.	Unit	Remark
Viewing Angle	θ	$\phi = 0^\circ$	25 °C	80	85	-	Deg	Note1
		$\phi = 180^\circ$	25 °C	80	85	-		
	θ	$\phi = 90^\circ$	25 °C	80	85	-		
		$\phi = 270^\circ$	25 °C	80	85	-		
Brightness	L_{br}	--	-	300	350	-	Cd/m2	
Luminance Uniformity	ΔL	--	-	75		-		
Contrast Ratio	CR	--	25 °C	1000	1500	-	--	Note2
Response Time	T_r+T_f	$\theta = 0^\circ$ $\phi = 0^\circ$	25 °C	-	30	40	ms	Note3
Color of CIE Coordinate	White	X	25 °C	-0.03	0.263	+0.03	--	BM-7A
		Y	25 °C		0.275			
	Red	X	25 °C		0.647			
		Y	25 °C		0.338			
	Green	X	25 °C		0.313			
		Y	25 °C		0.618			
	Blue	X	25 °C		0.151			
		Y	25 °C		0.060			
Transmittance (with polarizer)	--	--	--	4.6	5.5	-	%	--

Note 1 Definition of Viewing Angle:

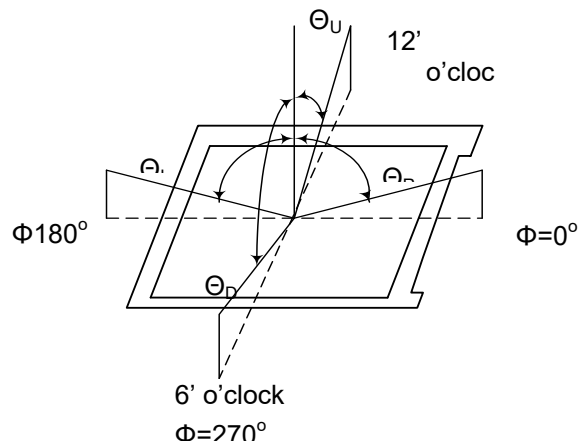

Note 2: Definition of Contrast Ratio (CR) :
measured at the center point of panel

$$CR = \frac{\text{Luminance with all pixels white}}{\text{Luminance with all pixels black}}$$

Note 3: Definition of Response Time : Sum of Tr and Tf :

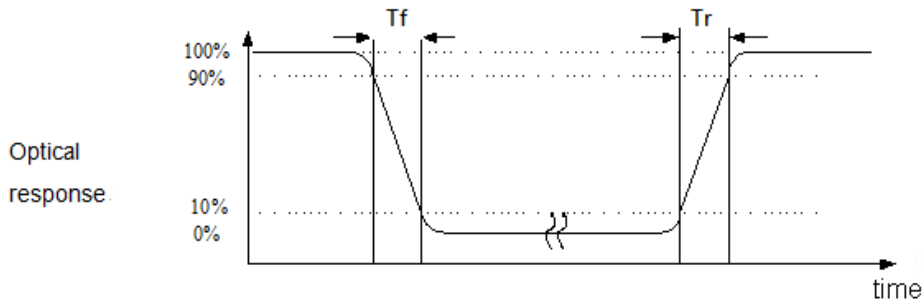

6. Reliability

Contents of Reliability Tests

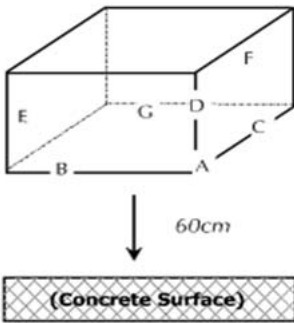
No.	Item	Conditions	Note
1	High Temperature Operation	70°C±2°C, 120 hrs	
2	Low Temperature Operation	-20°C±2°C, 120 hrs	
3	High Temperature Storage	80°C±2°C, 120 hrs	
4	Low Temperature Storage	-30°C±2°C, 120 hrs	
5	High Temperature /Humidity Operation	60°C±2°C, 90% RH, 120 hrs	
6	Temperature Cycling	-10°C→25°C→60°C→25°C→-10°C 30min 5min 30min 5min 30min 10 cycle.	
7	Vibration Test	Total fixed amplitude:1.5mm. Vibration Frequency:10~55Hz One cycle 60 seconds to 3 direction of X,Y,Z each 15 minutes.	
8	ESD Test	Air Discharge:Apple ±4KV with 5 times. Contact Discharge:Apple ±2KV with 5 times.	
9	Drop Test	To be measured after dropping from 60cm high on the concrete surface in packing state.  <i>Dropping method corner dropping:</i> <i>A corner: Once edge dropping.</i> <i>B, C, D edge: Once face dropping.</i> <i>E, F, G face: Once.</i>	

Note:

No charge on display and in operation under the following test condition.

Please note that the reliability test project requires the use of virgin samples

Condition : Unless otherwise specified ,tests will be conducted under the following condition.

Temperature:20°C±5°C.

Humidity:65±5%RH.

Tests will be not conducted under functioning state.

7. Package Specifications

Item		Quantity	
Module		660	per Primary Box
Holding Trays	(A)	15	per Primary Box
Total Trays	(B)	16	per Primary Box (Including 1 Empty Tray)
Primary Box	(C)	1~4	per Carton (4 as Major / Maximum)

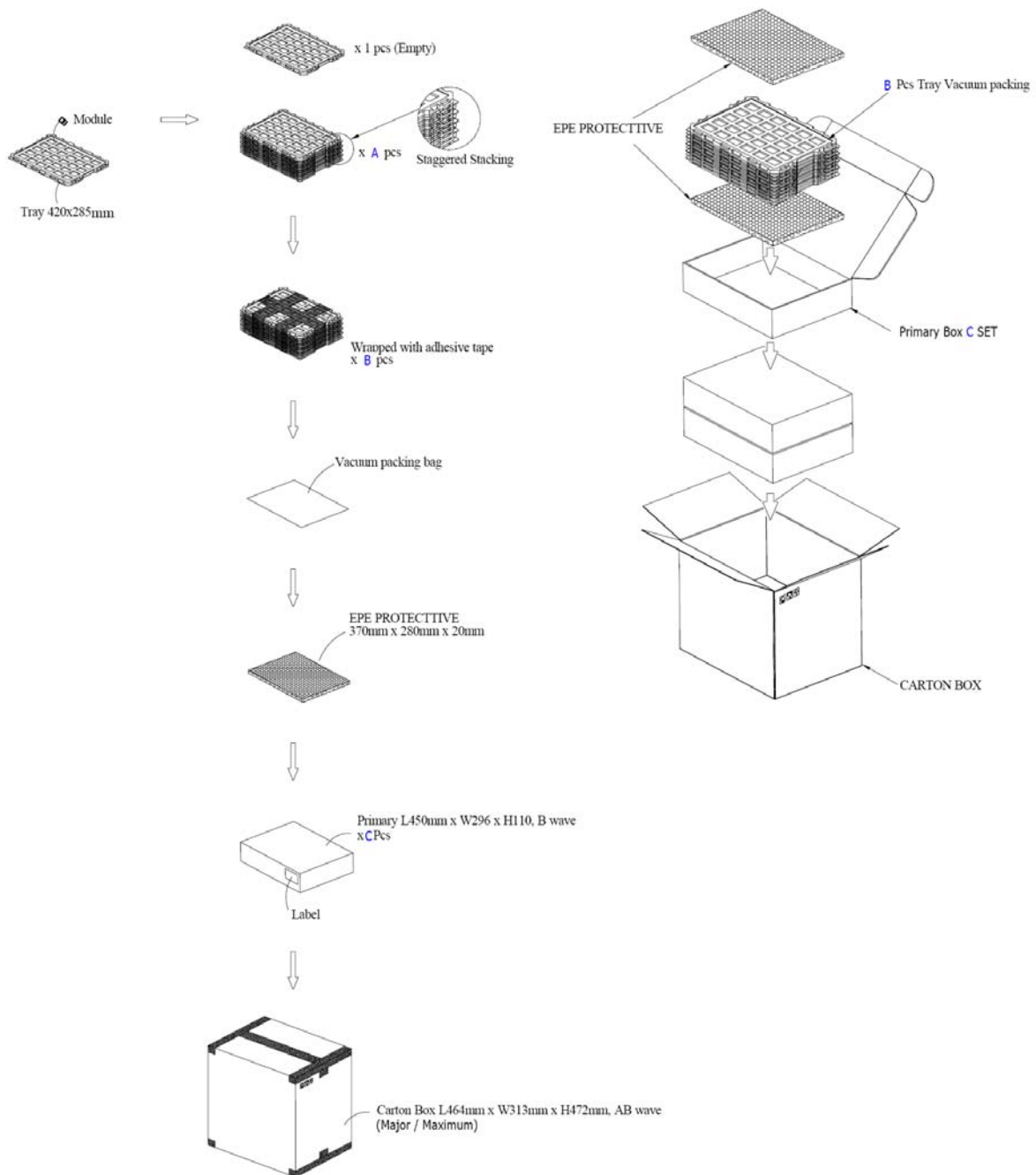

8. Incoming Inspection Standards

8.1. Inspection and Environment Conditions

8.1.1. Inspection Conditions:

- (1) Inspection Distance :35 cm±5cm
- (2) View Angle : Light-on Inspection Angle: ±5°
Cosmetic Inspection Angle: ±45°

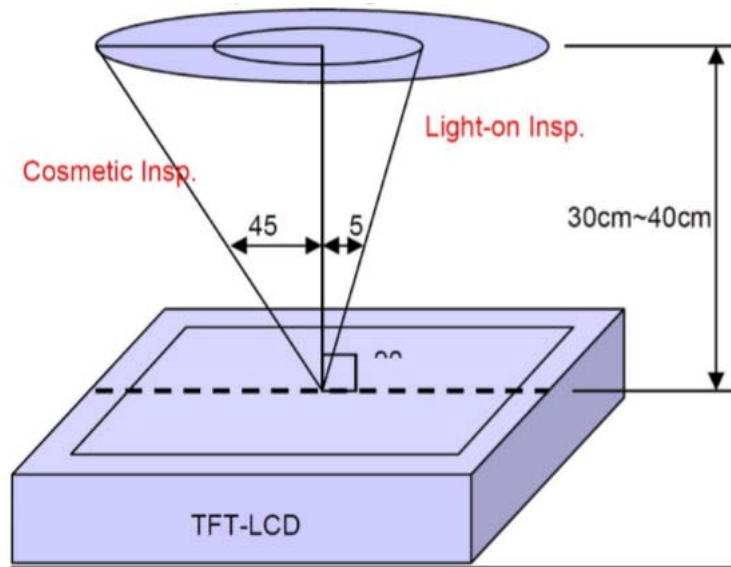

(perpendicular to LCD panel surface)

8.1.2 Environment Conditions:

Ambient Temperature		23°C±5°C
Ambient Humidity		55±10%RH
Ambient Illumination	Cosmetic Inspection	More than 600 Lux
	Functional Inspection	300~500 Lux

8.1.3 Sampling Conditions:

- (1) Lot Size:Quantity of shipment lot per model
- (2) Sampling Method:

Sampling Plan		MIL-STD-105E
		Normal Inspection, Single Sampling
		Level II
AQL	Major Defect	0.65%
	Minor Defect	1.5%

8.1.4 Inspection Criteria

8.1.4.1 Cosmetic Inspection(Panel):

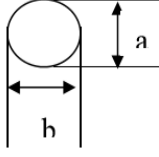
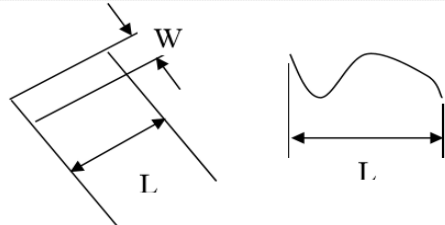
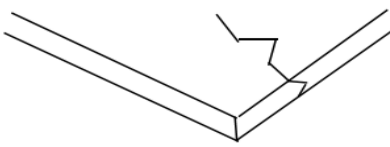
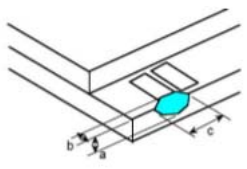
Check Item	Classification	Criteria(Unit: mm)															
Black / White spot Foreign material (Round type) Pinholes Stain Particles inside cell.	Minor	 <table border="1" data-bbox="986 392 1380 721"> <thead> <tr> <th>Size \ Area</th> <th>Acc. Qty</th> </tr> </thead> <tbody> <tr> <td>$\phi \leq 0.10$</td> <td>Ignore</td> </tr> <tr> <td>$0.10 < \phi \leq 0.15$</td> <td>2</td> </tr> <tr> <td>$0.15 < \phi \leq 0.20$</td> <td>1</td> </tr> <tr> <td>$0.20 < \phi$</td> <td>0</td> </tr> <tr> <td>Total</td> <td>2 no include $\phi \leq 0.10$</td> </tr> </tbody> </table> <p>$\phi = (a + b) / 2$</p> <p>Distance between 2 defects should more than 5mm apart.</p>	Size \ Area	Acc. Qty	$\phi \leq 0.10$	Ignore	$0.10 < \phi \leq 0.15$	2	$0.15 < \phi \leq 0.20$	1	$0.20 < \phi$	0	Total	2 no include $\phi \leq 0.10$			
Size \ Area	Acc. Qty																
$\phi \leq 0.10$	Ignore																
$0.10 < \phi \leq 0.15$	2																
$0.15 < \phi \leq 0.20$	1																
$0.20 < \phi$	0																
Total	2 no include $\phi \leq 0.10$																
Black and White line Scratch Foreign material (Line type)	Minor	 <table border="1" data-bbox="798 1041 1316 1254"> <thead> <tr> <th>Length</th> <th>Width</th> <th>Acc. Qty</th> </tr> </thead> <tbody> <tr> <td>/</td> <td>$W \leq 0.03$</td> <td>Ignore</td> </tr> <tr> <td>$L \leq 2$</td> <td>$0.03 < W \leq 0.05$</td> <td>1</td> </tr> <tr> <td>/</td> <td>$0.05 < W$</td> <td>0</td> </tr> <tr> <td colspan="2">Total</td> <td>1</td> </tr> </tbody> </table> <p>Distance between 2 defects should more than 5mm apart. Scratches not viewable through the back of the display are acceptable.</p>	Length	Width	Acc. Qty	/	$W \leq 0.03$	Ignore	$L \leq 2$	$0.03 < W \leq 0.05$	1	/	$0.05 < W$	0	Total		1
Length	Width	Acc. Qty															
/	$W \leq 0.03$	Ignore															
$L \leq 2$	$0.03 < W \leq 0.05$	1															
/	$0.05 < W$	0															
Total		1															
Glass Crack	Minor	 <p>LCD with extensible crack line is unacceptable(When press the cracked LCD Area, the line will expand,we define it is extensible crack line)</p>															
Glass Chipping Pad Area 	Minor	<table border="1" data-bbox="805 1825 1276 1926"> <thead> <tr> <th>Length and Width</th> <th>Acc. Qty</th> </tr> </thead> <tbody> <tr> <td>$c < 5.0, b < 0.4$</td> <td>Ignore</td> </tr> </tbody> </table>	Length and Width	Acc. Qty	$c < 5.0, b < 0.4$	Ignore											
Length and Width	Acc. Qty																
$c < 5.0, b < 0.4$	Ignore																

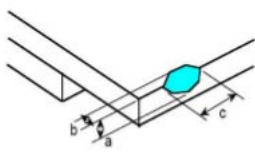
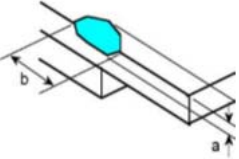
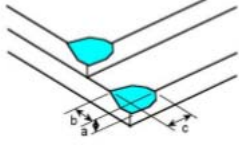
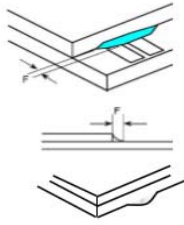
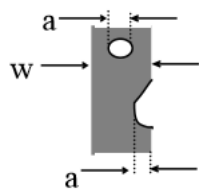
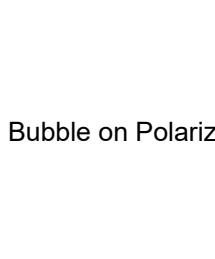
Check Item	Classification	Criteria(Unit: mm)										
Glass Chipping Rear Of Pad Area 	Minor	<table border="1"> <thead> <tr> <th>Length and Width</th> <th>Acc. Qty</th> </tr> </thead> <tbody> <tr> <td>$c > 3.0, b < 1.0$</td> <td>1</td> </tr> <tr> <td>$c < 3.0, b < 1.0$</td> <td>2</td> </tr> <tr> <td>$c < 3.0, b < 0.5$</td> <td>4</td> </tr> <tr> <td colspan="2">$a < \text{Glass Thickness}$</td> </tr> </tbody> </table>	Length and Width	Acc. Qty	$c > 3.0, b < 1.0$	1	$c < 3.0, b < 1.0$	2	$c < 3.0, b < 0.5$	4	$a < \text{Glass Thickness}$	
Length and Width	Acc. Qty											
$c > 3.0, b < 1.0$	1											
$c < 3.0, b < 1.0$	2											
$c < 3.0, b < 0.5$	4											
$a < \text{Glass Thickness}$												
Glass Chipping Except Pad Area 	Minor	<table border="1"> <thead> <tr> <th>Length and Width</th> <th>Acc. Qty</th> </tr> </thead> <tbody> <tr> <td>$c \leq 0.6, b < 5.0$</td> <td>Ignore</td> </tr> <tr> <td colspan="2">$a < \text{Glass Thickness}$</td> </tr> </tbody> </table>	Length and Width	Acc. Qty	$c \leq 0.6, b < 5.0$	Ignore	$a < \text{Glass Thickness}$					
Length and Width	Acc. Qty											
$c \leq 0.6, b < 5.0$	Ignore											
$a < \text{Glass Thickness}$												
Glass Corner Chipping 	Minor	<table border="1"> <thead> <tr> <th>Length and Width</th> <th>Acc. Qty</th> </tr> </thead> <tbody> <tr> <td>$c < 2.0, b < 1.5$</td> <td>Ignore</td> </tr> <tr> <td>$c < 1.5, b < 2$</td> <td>Ignore</td> </tr> <tr> <td colspan="2">$a < \text{Glass Thickness}$</td> </tr> </tbody> </table>	Length and Width	Acc. Qty	$c < 2.0, b < 1.5$	Ignore	$c < 1.5, b < 2$	Ignore	$a < \text{Glass Thickness}$			
Length and Width	Acc. Qty											
$c < 2.0, b < 1.5$	Ignore											
$c < 1.5, b < 2$	Ignore											
$a < \text{Glass Thickness}$												
Glass Burr 	Minor	<p>Glass burr don't affect assemble and module dimension.</p> <table border="1"> <thead> <tr> <th>Length</th> <th>Acc. Qty</th> </tr> </thead> <tbody> <tr> <td>$F < 0.5$</td> <td>Ignore</td> </tr> </tbody> </table>	Length	Acc. Qty	$F < 0.5$	Ignore						
Length	Acc. Qty											
$F < 0.5$	Ignore											
FPC Defect 	Minor	<ol style="list-style-type: none"> Dent , pinhole width $a < W/2$. (W:circuitry width) Open circuit is unacceptable. No oxidation, contamination and distortion. 										
Bubble on Polarizer 	Minor	<table border="1"> <thead> <tr> <th>Diameter</th> <th>Acc. Qty</th> </tr> </thead> <tbody> <tr> <td>$\phi \leq 0.15$</td> <td>Ignore</td> </tr> <tr> <td>$0.15 < \phi \leq 0.20$</td> <td>2</td> </tr> <tr> <td>$0.20 < \phi \leq 0.30$</td> <td>1</td> </tr> <tr> <td>$0.3 < \phi$</td> <td>None</td> </tr> </tbody> </table>	Diameter	Acc. Qty	$\phi \leq 0.15$	Ignore	$0.15 < \phi \leq 0.20$	2	$0.20 < \phi \leq 0.30$	1	$0.3 < \phi$	None
Diameter	Acc. Qty											
$\phi \leq 0.15$	Ignore											
$0.15 < \phi \leq 0.20$	2											
$0.20 < \phi \leq 0.30$	1											
$0.3 < \phi$	None											

Check Item	Classification	Criteria(Unit: mm)										
Dent on Polarizer	Minor	<table border="1"> <thead> <tr> <th>Diameter</th> <th>Acc. Qty</th> </tr> </thead> <tbody> <tr> <td>$\varphi \leq 0.15$</td> <td>Ignore</td> </tr> <tr> <td>$0.15 < \varphi \leq 0.20$</td> <td>2</td> </tr> <tr> <td>$0.20 < \varphi \leq 0.30$</td> <td>1</td> </tr> <tr> <td>$0.3 < \varphi$</td> <td>None</td> </tr> </tbody> </table>	Diameter	Acc. Qty	$\varphi \leq 0.15$	Ignore	$0.15 < \varphi \leq 0.20$	2	$0.20 < \varphi \leq 0.30$	1	$0.3 < \varphi$	None
Diameter	Acc. Qty											
$\varphi \leq 0.15$	Ignore											
$0.15 < \varphi \leq 0.20$	2											
$0.20 < \varphi \leq 0.30$	1											
$0.3 < \varphi$	None											
Screen deformation 	/	<p>Test for insertion of plug gauge at highest warping point: $H \leq 0.25\text{mm}$ The client has special requirements, according to drawing.</p>										
Bezel	/	<p>1.No rust, distortion on the Bezel. 2.No visible fingerprints, stains or other contamination.</p>										
Touch Panel	/	<p>D:Diameter W: width L: length 1.Spot: $D \leq 0.2$ is acceptable $0.2 < D \leq 0.3$, acceptable Inspection and Environment Conditions 2dots are acceptable and the distance between defects Should more than 5mm. $D > 0.3$ is unacceptable 2.Dent: $D > 0.3$ is unacceptable. 3.Scratch: $W \leq 0.03, L \leq 10$ is acceptable, $0.03 < W \leq 0.1, L \leq 10$, acceptable Inspection and Environment Conditions Distance between 2 defects should more than 5 mm. $W > 0.1$ is unacceptable.</p>										
PCB	/	<p>1.No distortion or contamination on PCB terminals. 2.All components on PCB must same as documented on the BOM/component layout. 3.Follow IPC-A-600F.</p>										
Soldering	/	Follow IPC-A-610C standard.										
Leak	/	Yellow light, OK。 White light, According to the limit sample										

Check Item	Classification	Criteria(Unit: mm)
Electrical Defect	Major	<p>The below defects must be rejected.</p> <ol style="list-style-type: none"> 1. Missing vertical / horizontal segment. 2. Abnormal Display. 3. No function or no display. 4. Current exceeds product specifications. 5. LCD viewing angle defect. 6. No Backlight. 7. Dark Backlight. 8. Touch Panel no function. 9. Dark Dot –one Allowed. 10. Bright Dot- one Allowed.

9. Precautions When Using These TFT Display Modules

9.1 Handling Precautions

- 1) Since the display panel is being made of glass, do not apply mechanical impacts such as dropping from a high position.
- 2) If the display panel is broken by some accident and the internal organic substance leaks out, be careful not to inhale nor lick the organic substance.
- 3) If pressure is applied to the display surface or its neighborhood of the TFT display module, the cell structure may be damaged and be careful not to apply pressure to these sections.
- 4) The polarizer covering the surface of the TFT display module is soft and easily scratched. Please be careful when handling the TFT display module.
- 5) When the surface of the polarizer of the TFT display module has soil, clean the surface. It takes advantage of by using following adhesion tape.
 - * Scotch Mending Tape No. 810 or an equivalent

Never try to breathe upon the soiled surface nor wipe the surface using cloth containing solvent such as ethyl alcohol, since the surface of the polarizer will become cloudy.

Also, pay attention that the following liquid and solvent may spoil the polarizer:

 - * Water
 - * Ketone
 - * Aromatic Solvents
- 6) Hold TFT display module very carefully when placing TFT display module into the system housing. Do not apply excessive stress or pressure to TFT display module. And, do not over bend the film with electrode pattern layouts. These stresses will influence the display performance. Also, secure sufficient rigidity for the outer cases.

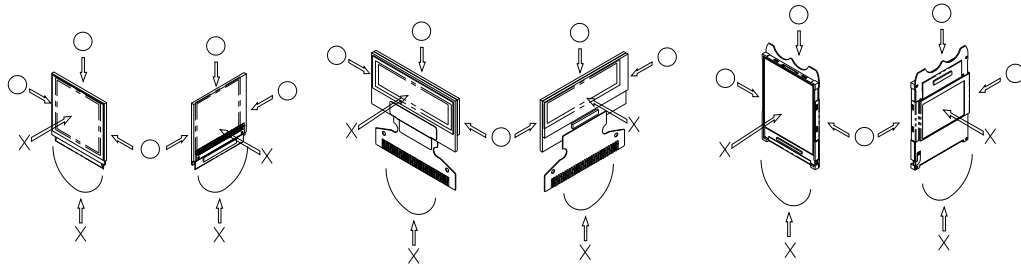

- 7) Do not apply stress to the driver IC and the surrounding molded sections.
- 8) Do not disassemble nor modify the TFT display module.
- 9) Do not apply input signals while the logic power is off.

- 10) Pay sufficient attention to the working environments when handling TFT display modules to prevent occurrence of element breakage accidents by static electricity.
 - * Be sure to make human body grounding when handling TFT display modules.
 - * Be sure to ground tools to use or assembly such as soldering irons.
 - * To suppress generation of static electricity, avoid carrying out assembly work under dry environments.
 - * Protective film is being applied to the surface of the display panel of the TFT display module. Be careful since static electricity may be generated when exfoliating the protective film.
- 11) Protection film is being applied to the surface of the display panel and removes the protection film before assembling it. At this time, if the TFT display module has been stored for a long period of time, residue adhesive material of the protection film may remain on the surface of the display panel after removed of the film. In such case, remove the residue material by the method introduced in the above Section 5).
- 12) If electric current is applied when the TFT display module is being dewed or when it is placed under high humidity environments, the electrodes may be corroded and be careful to avoid the above.

9.2 Storage Precautions

- 1) When storing TFT display modules, put them in static electricity preventive bags avoiding exposure to direct sun light nor to lights of fluorescent lamps. and, also, avoiding high temperature and high humidity environment or low temperature (less than 0°C) environments. (We recommend you to store these modules in the packaged state when they were shipped from .)

At that time, be careful not to let water drops adhere to the packages or bags nor let dewing occur with them.
- 2) If electric current is applied when water drops are adhering to the surface of the TFT display module, when the TFT display module is being dewed or when it is placed under high humidity environments, the electrodes may be corroded and be careful about the above.

9.3 Designing Precautions

- 1) The absolute maximum ratings are the ratings which cannot be exceeded for TFT display module, and if these values are exceeded, panel damage may be happen.
- 2) To prevent occurrence of malfunctioning by noise, pay attention to satisfy the V_{IL} and V_{IH} specifications and, at the same time, to make the signal line cable as short as possible.
- 3) We recommend you to install excess current preventive unit (fuses, etc.) to the power circuit (V_{DD}). (Recommend value: 0.5A)
- 4) Pay sufficient attention to avoid occurrence of mutual noise interference with the neighboring devices.
- 5) As for EMI, take necessary measures on the equipment side basically.
- 6) When fastening the TFT display module, fasten the external plastic housing section.
- 7) If power supply to the TFT display module is forcibly shut down by such errors as taking out the main battery while the TFT display panel is in operation, we cannot guarantee the quality of this OEL display module.
- 8) The electric potential to be connected to the rear face of the IC chip should be as follows:
 - * Connection (contact) to any other potential than the above may lead to rupture of the IC.

9.4 Precautions when disposing of the TFT display modules

- 1) Request the qualified companies to handle industrial wastes when disposing of the TFT display modules. Or, when burning them, be sure to observe the environmental and hygienic laws and regulations.

9.5 Other Precautions

- 1) When an TFT display module is operated for a long of time with fixed pattern may remain as an after image or slight contrast deviation may occur. Nonetheless, if the operation is interrupted and left unused for a while, normal state can be restored. Also, there will be no problem in the reliability of the module.
- 2) To protect TFT display modules from performance drops by static electricity rapture, etc., do not touch the following sections whenever possible while handling the TFT display modules.
 - * Pins and electrodes
 - * Pattern layouts such as the FPC

- 3) With this TFT display module, the TFT driver is being exposed. Generally speaking, semiconductor elements change their characteristics when light is radiated according to the principle of the solar battery. Consequently, if this TFT driver is exposed to light, malfunctioning may occur.
 - * Design the product and installation method so that the TFT driver may be shielded from light in actual usage.
 - * Design the product and installation method so that the TFT driver may be shielded from light during the inspection processes.
- 4) Although this TFT display module stores the operation state data by the commands and the indication data, when excessive external noise, etc. enters into the module, the internal status may be changed. It therefore is necessary to take appropriate measures to suppress noise generation or to protect from influences of noise on the system design.
- 5) We recommend you to construct its software to make periodical refreshment of the operation statuses (re-setting of the commands and re-transference of the display data) to cope with catastrophic noise.

10. Warranty:

The warranty period shall last twelve (12) months from the date of delivery. Buyer shall be completed to assemble all the processes within the effective twelve (12) months. Limito technology Inc. shall be liable for replacing any products which contain defective material or process which do not conform to the product specification, applicable drawings and specifications during the warranty period. All products must be preserved, handled and appearance to permit efficient handling during warranty period. The warranty coverage would be exclusive while the returned goods are out of the terms above.

11. Notice:

No part of this material may be reproduced or duplicated in any form or by any means without the written permission of reserves the right to make changes to this material without notice. does not assume any liability of any kind arising out of any inaccuracies contained in this material or due to its application or use in any product or circuit and, further, there is no representation that this material is applicable to products requiring high level reliability, such as, medical products. Moreover, no license to any intellectual property rights is granted by implication or otherwise, and there is no representation or warranty that anything made in accordance with this material will be free from any patent or copyright infringement of a third party. This material or portions thereof may contain technology or the subject relating to strategic products under the control of Foreign Exchange and Foreign Trade Law of Taiwan and may require an export license from the Ministry of International Trade and Industry or other approval from another government agency.