

ESP32-S3	LCD	USB	UART	RTC	SHTC3	Buzzer	MIC	GMI8658C	SYS
GPIO1									BAT_ADC
GPIO2									
GPIO3									
GPIO4	LCD DC								
GPIO5	LCD CS								
GPIO6	LCD SCL								
GPIO7	LCD SDA								
GPIO8	LCD RST								
GPIO9									
GPIO10				RTC_SCL	SHT_SCL				ESP32_SCL
GPIO11				RTC_SDA	SHT_SDA				ESP32_SDA
GPIO12									
GPIO13									
GPIO14									
GPIO15	LCD_BL								
GPIO16									
GPIO17									
GPIO18									
GPIO19		USB_P							SYS_EN
GPIO20		USB_N							SYS_OUT
GPIO21									
GPIO22									
GPIO23									
GPIO24									
GPIO25									
GPIO26									
GPIO27									
GPIO28									
GPIO29									
GPIO30									
GPIO31									
GPIO32									
GPIO33									
GPIO34									
GPIO35									
GPIO36									
GPIO37									
GPIO38									
GPIO39									
GPIO40									
GPIO41									
GPIO42									
GPIO43									
GPIO44									
GPIO45									
GPIO46									

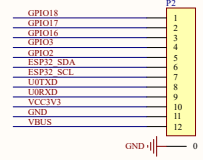

RTC

Buzzer

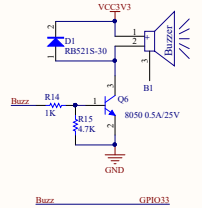
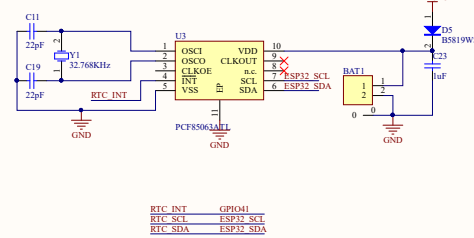
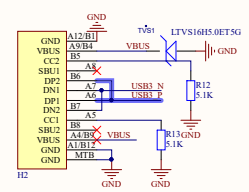
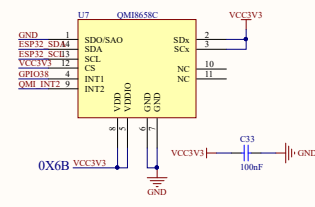
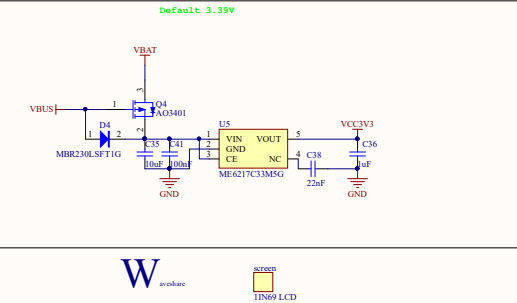
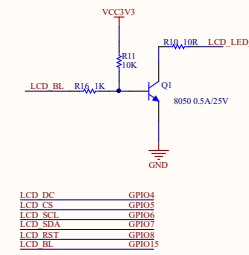
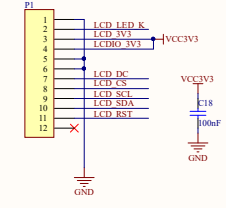

LCD

ESP32-S3-LCD-1.69

6/9-Axis

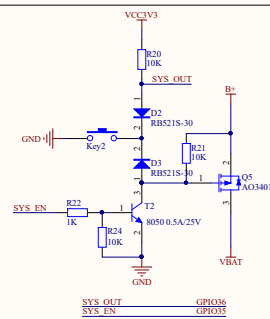
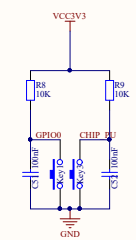
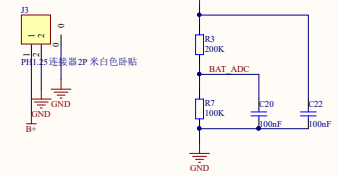
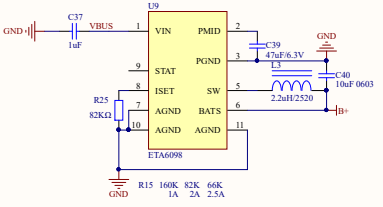

POWER Supply

KEYS