

USB

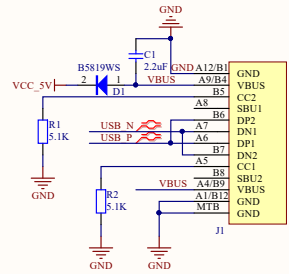

RGB

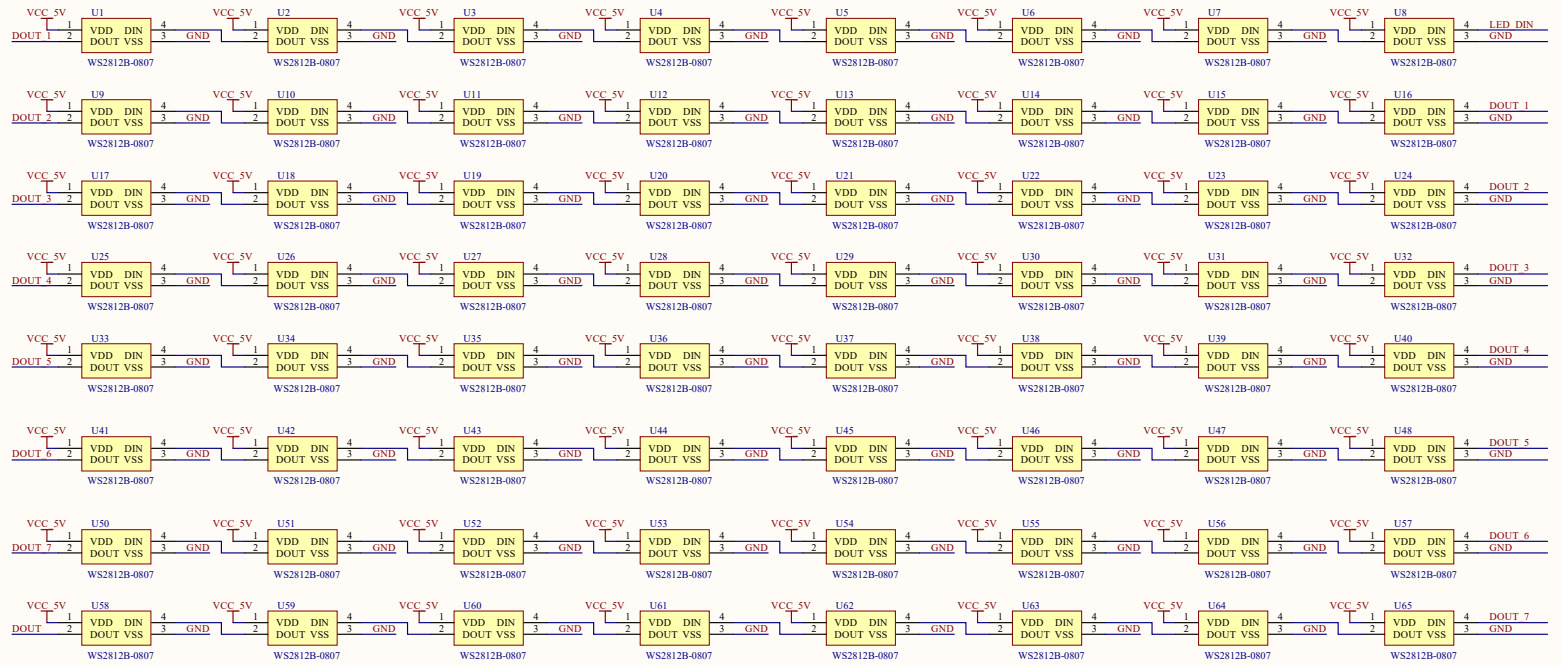

Power

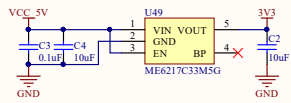

IMU_SDA IO11
IMU_SCL IO12
IMU_INT1 IO10
IMU_INT2 IO13

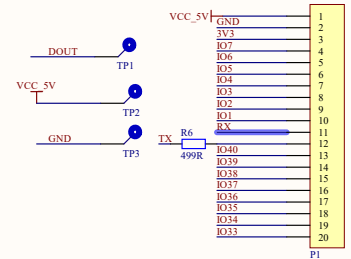
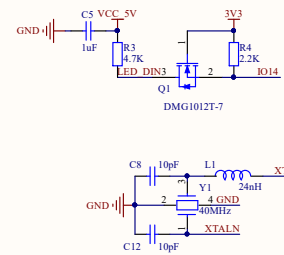
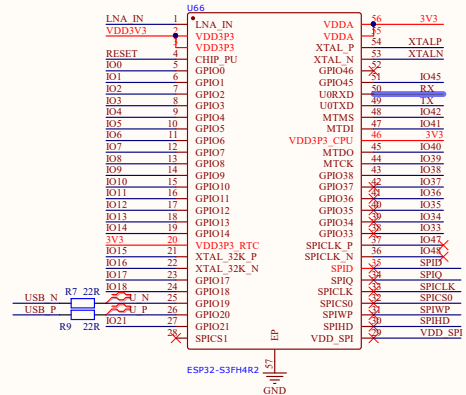
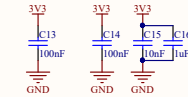
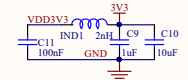
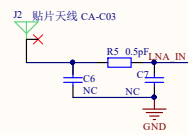
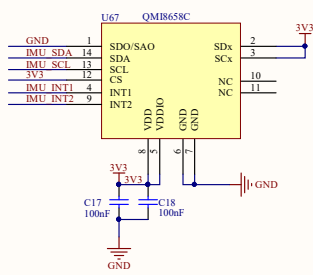

Waveshare
ESP32-S3-Matrix