

Type C Power

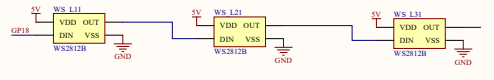

按键

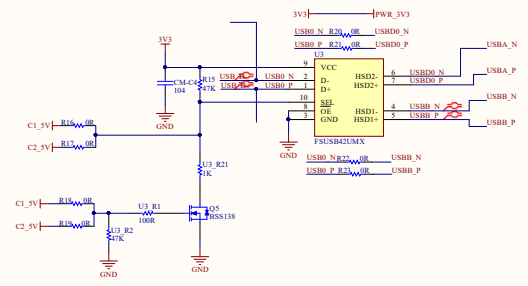
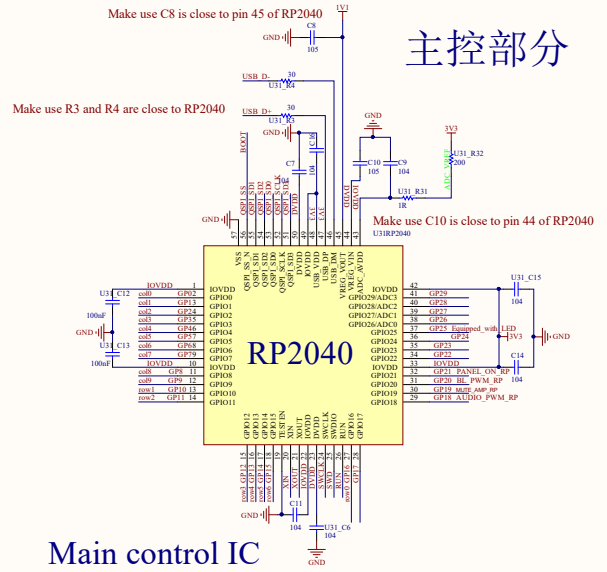
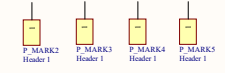

主控部分

Main control IC

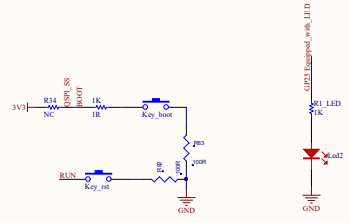

pico_RST pico_BOOT 按键

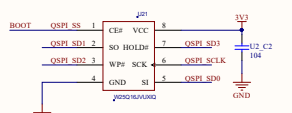

FLASH

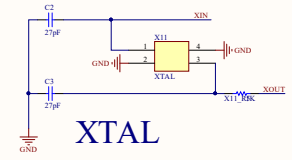

XTAL

Title		
Size	Number	Revision
A4		
Date:	2024/2/29	Sheet of
File:	C:\Users\RP2040\Documents\Keyboards3\SchDoc1	1 of 1