

THE OFFICIAL RASPBERRY PI

# CAMERA GUIDE

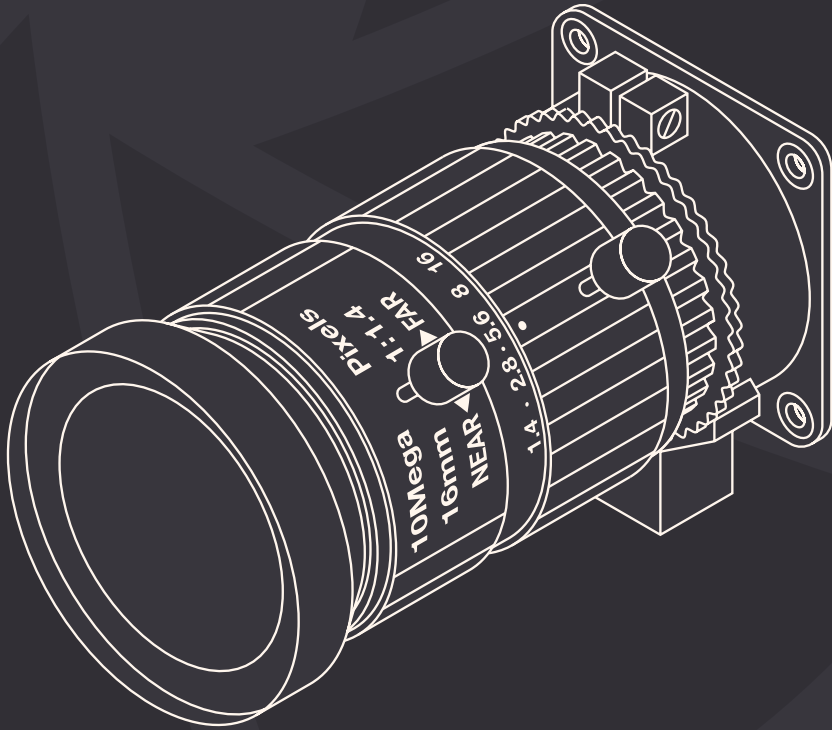

FOR CAMERA MODULE & HIGH QUALITY CAMERA







First published in 2020 by Raspberry Pi Trading Ltd, Maurice Wilkes Building,  
St. John's Innovation Park, Cowley Road, Cambridge, CB4 0DS

Publishing Director: Russell Barnes • Editor: Phil King  
Contributors: Dan Aldred, Wesley Archer, Jody Carter, PJ Evans,  
Richard Hayler & family, James Singleton, Rob Zwetsloot,  
the Raspberry Pi Foundation Education Team

Design: Critical Media

CEO: Eben Upton

ISBN: 978-1-912047-52-9

The publisher and contributors accept no responsibility in respect of any omissions or errors relating to goods, products or services referred to or advertised in this book. Except where otherwise noted, the content of this book is licensed under a Creative Commons Attribution-NonCommercial-ShareAlike 3.0 Unported (CC BY-NC-SA 3.0)



# Welcome to The Official Raspberry Pi Camera Guide

**O**ne of the most popular add-ons for the Raspberry Pi, the official Camera Module – or the new High Quality Camera – turns your favourite single-board computer into a powerful digital camera. Launched back in 2013, the original Camera Module was succeeded by the higher-spec v2 in April 2016. The High Quality Camera was launched in April 2020, offers Ultra HD image resolution, and enables you to attach any C- or CS-mount lens.

In this book we'll show you how to get started with your Raspberry Pi camera, taking photos and videos from the command line and writing Python programs to automate the process. We'll reveal how to create time-lapse and slow-motion videos, before moving on to exciting projects including a Minecraft photo booth, wildlife camera trap, and smart door with video. There are just so many things you can do with a Raspberry Pi camera!

**Phil King**, *Editor*

# Contents

<b>Chapter 1: Getting started</b>	<b>008</b>
Set up and connect your camera and start taking shots	
<b>Chapter 2: Precise camera control</b>	<b>016</b>
Use command-line switches to access camera options and effects	
<b>Chapter 3: Time-lapse photography</b>	<b>020</b>
Take photos at regular intervals, then turn the images into a video	
<b>Chapter 4: High-speed photography</b>	<b>024</b>
Film dazzling slow-motion clips of exciting events	
<b>Chapter 5: Control the camera from Python</b>	<b>028</b>
Use the picamera library to access the camera in Python programs	
<b>Chapter 6: Stop-motion and selfies</b>	<b>034</b>
Wire up a physical push-button to take photos	
<b>Chapter 7: Flash photography using an LED</b>	<b>040</b>
Add an LED flash to shoot images in low light	
<b>Chapter 8: Make a Minecraft photo booth</b>	<b>046</b>
Build a booth in Minecraft that takes photos of the real world	

<b>Chapter 9: Make a spy camera</b>	<b>050</b>
Set up a motion-activated spy camera in your room	
<b>Chapter 10: Smart door</b>	<b>054</b>
See who's at the door and know when the post has arrived	
<b>Chapter 11: Car Spy Pi</b>	<b>062</b>
Use ANPR to identify who's parked on your driveway	
<b>Chapter 12: Build a wildlife camera trap</b>	<b>070</b>
Detect and photograph animals in your back garden	
<b>Chapter 13: Take your camera underwater</b>	<b>076</b>
Explore the underwater world with your Raspberry Pi and camera	
<b>Chapter 14: Install a bird box camera</b>	<b>086</b>
Observe nesting birds without disturbing them	
<b>Chapter 15: Live-stream video and stills</b>	<b>092</b>
Stream video and regular stills to a remote computer	
<b>Chapter 16: Set up a security camera</b>	<b>102</b>
Protect your home from intruders using motionEyeOS	
<b>Chapter 17: Quick reference</b>	<b>108</b>
A guide to the camera hardware, commands, and picamera Python library	

## Chapter 1

# Getting started

Find out how to connect your High Quality Camera or Camera Module, enable it, and take your first shots

**I**n this chapter, we show you how to connect the High Quality Camera or Camera Module to your Raspberry Pi using the supplied ribbon cable. We will then enable it in Raspbian, before entering some commands in a Terminal window to start shooting photos and video. Let's get started...

## 01. High Quality Camera

The High Quality Camera (HQ Camera for short) can capture higher-resolution images than the standard Camera Module. Unlike the latter, it doesn't have a lens already attached. Instead, it can be used with any standard C- or CS-mount lens; 6 mm and 16 mm lenses are available to purchase with the camera to help you get started.

### 6 mm CS-mount lens

A low-cost 6 mm lens is available for the HQ Camera. This lens is suitable for basic photography. It can also be used for macro photography because it can focus objects at very short distances.



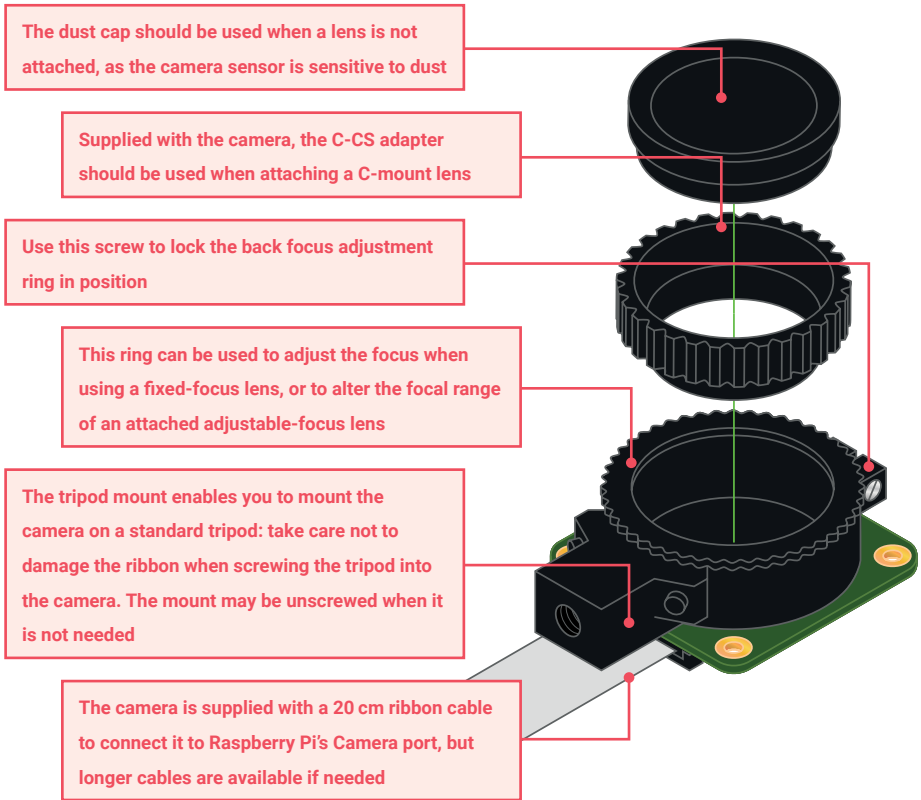

## 01 Fitting the lens to the camera

The 6 mm lens is a CS-mount device, so it has a short back focus and does not need the C-CS adapter that comes with the HQ Camera. Rotate the lens clockwise all the way into the back focus adjustment ring.

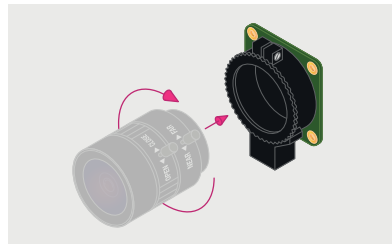

## 02 Back focus adjustment ring and lock screw

The back focus adjustment ring should be screwed in fully for the shortest possible back-focal length. Use the back focus lock screw to make sure it does not move out of this position when adjusting the aperture or focus.

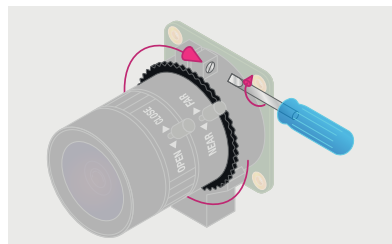

### 03 Aperture

To adjust the aperture, hold the camera with the lens facing away from you. Turn the middle ring while holding the outer ring, furthest from the camera, steady. Turn clockwise to close the aperture and reduce image brightness. Turn anti-clockwise to open the aperture. Once you are happy with the light level, tighten the screw on the side of the lens to lock the aperture.

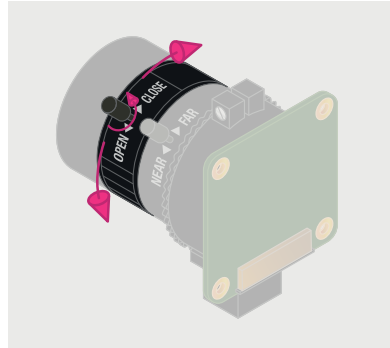

### 04 Focus

To adjust focus, hold the camera with the lens facing away from you. Hold the outer two rings of the lens; this is easier if the aperture is locked as described above. Turn the camera and the inner ring anti-clockwise relative to the two outer rings to focus on a nearby object. Turn them clockwise to focus on a distant object. You may find you need to adjust the aperture again after this.

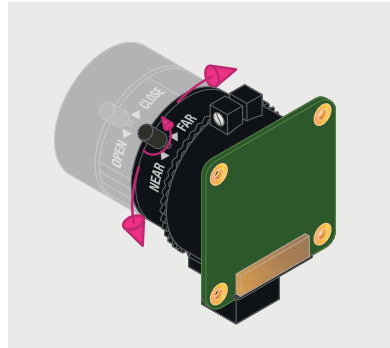

## 16 mm C-mount lens

The 16 mm lens provides a higher-quality image than the 6 mm lens. It has a narrow angle of view which is more suited to viewing distant objects.



### 01 Fitting the C-CS adapter

Ensure the C-CS adapter that comes with the HQ Camera is fitted to the 16 mm lens. The lens is a C-mount device, so it has a longer back focus than the 6 mm lens and therefore requires the adapter.

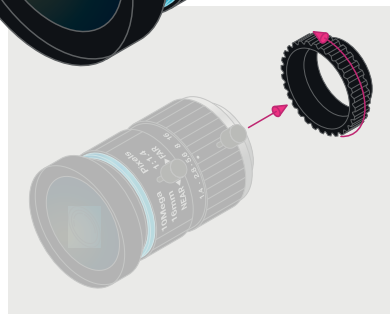

## 02 Fitting the lens to the camera

Rotate the 16 mm lens and C-CS adapter clockwise all the way into the back focus adjustment ring.

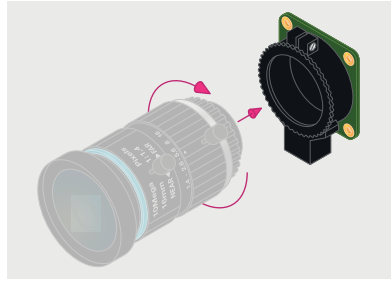

## 03 Back focus adjustment ring and lock screw

The back focus adjustment ring should be screwed in fully. Use the back focus lock screw to make sure it does not move out of this position when adjusting the aperture or focus.

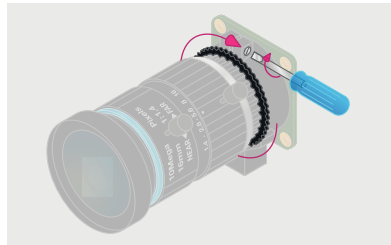

## 04 Aperture

To adjust the aperture, hold the camera with the lens facing away from you. Turn the inner ring, closest to the camera, while holding the camera steady. Turn clockwise to close the aperture and reduce image brightness. Turn anti-clockwise to open the aperture. When happy with the light level, tighten the screw on the side of the lens to lock the aperture into position.

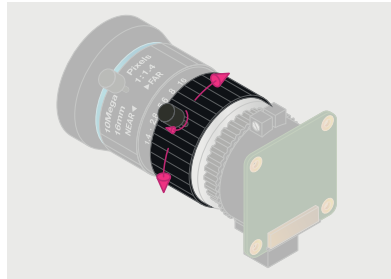

## 05 Focus

To adjust focus, hold the camera with the lens facing away from you. Turn the focus ring, labelled 'NEAR ◀▶ FAR', anti-clockwise to focus on a nearby object. Turn it clockwise to focus on a distant object. You may find you need to adjust the aperture again after this.

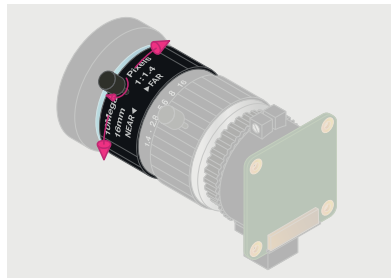

## 02. Connecting and using the camera

With your HQ Camera with lens – or your Camera Module – ready, it's time to connect it to Raspberry Pi and start to capture some images.

### 01 Connect ribbon cable to camera

On the HQ Camera or Camera Module board, you'll find a flat plastic connector. Carefully pull the sticking-out edges until the connector pulls part-way out. Slide the ribbon cable, with the silver edges downwards and the blue plastic facing upwards, under the flap you just pulled out, then push the flap gently back into place with a click (**Figure 1**); it doesn't matter which end of the cable you use. If the cable is installed properly, it will be straight and won't come out if you give it a gentle tug; if not, pull the flap out and try again.

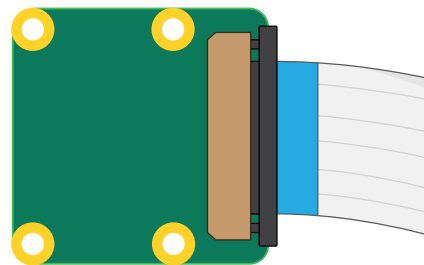

Figure 1

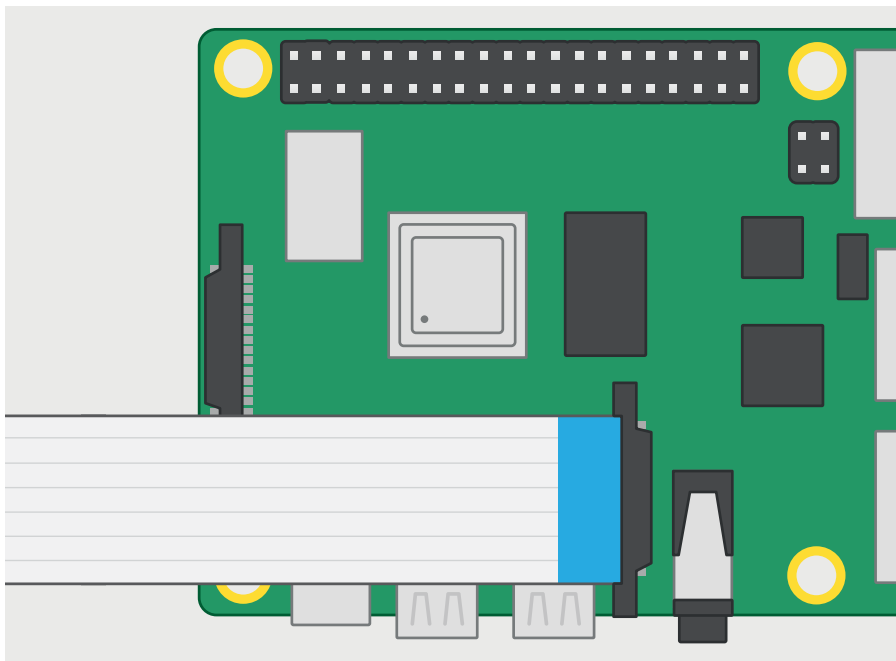
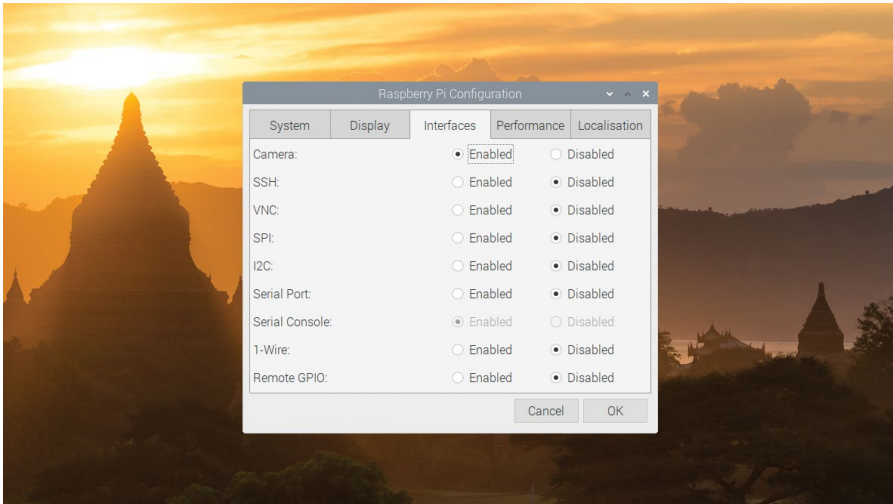

Figure 2





▣ **Figure 3**

## 02 Connect cable to Raspberry Pi

Find the Camera port on Raspberry Pi and pull the plastic flap gently upwards. With Raspberry Pi positioned so the HDMI port is facing you, slide the ribbon cable in so the silver edges are to your left and the blue plastic to your right (**Figure 2**), then gently push the flap back into place. If the cable is installed properly, it'll be straight and won't come out if you give it a gentle tug; if not, pull the flap out and try again.

If using a Raspberry Pi Zero, its Camera port is found on the edge of the board. However, as it's a smaller size than the regular one on other Raspberry Pi models, you'll need a camera adapter cable to use it.

## 03 Enable the camera

Connect the power supply back to Raspberry Pi and let it load Raspbian. Before you can use the camera, you'll need to tell Raspberry Pi it has one connected: in the Raspbian menu, select Preferences, then Raspberry Pi Configuration. When the tool has loaded, click the Interfaces tab, find the Camera entry in the list, and click on the round radio button to the left of 'Enabled' to switch it on (**Figure 3**). Click OK, and the tool will prompt you to reboot your Raspberry Pi. Do so and your camera will be ready to use.

## 04 Test the camera

To confirm that your camera is correctly installed, you can use the `raspistill` tool. This, along with `raspivid` for videos, is designed to capture images from the camera using Raspberry Pi's command-line interface (CLI). In the Raspbian menu, select Accessories, then

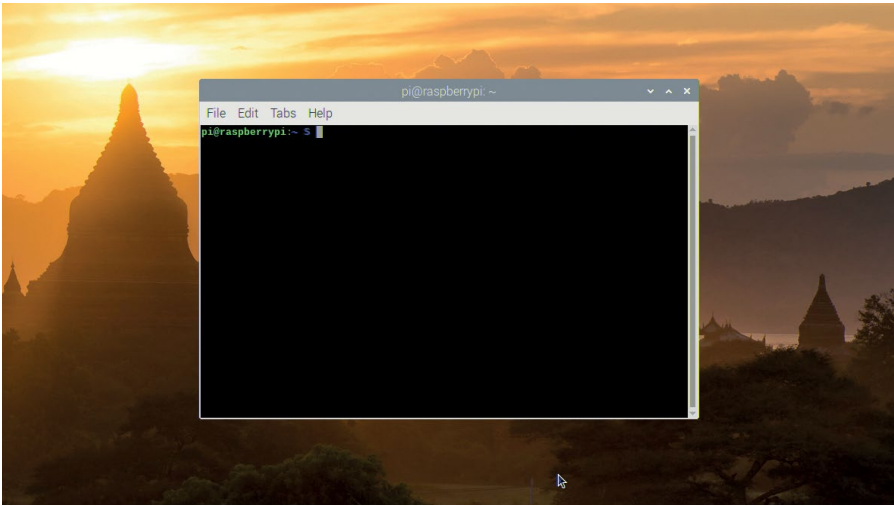

Figure 4

Terminal. A black window with green and blue writing in it will appear (Figure 4): this is the Terminal, which allows you to access the command-line interface.

To take a test shot, type the following into the Terminal:

```
raspistill -o test.jpg
```

As soon as you hit the **ENTER** key, you'll see a large picture of what the camera sees appear on-screen (Figure 5). This is called the live preview and, unless you tell **raspistill** otherwise, it will last for five seconds. After those five seconds are up, the camera will capture a single still picture and save it in your home folder under the name **test.jpg**. If you want to capture another, type the same command again – but make sure to change the output file name, after the **-o**, or you'll save over the top of your first picture.

## 05 More advanced commands

The **raspistill** command has a list of options so long that it borders on the intimidating. Don't worry – you won't need to learn them all, but there are a few that might be useful to you, such as:

```
raspistill -t 15000 -o newpic.jpg
```

The **-t** option changes the delay before the picture is taken, from the default five seconds to whatever time you give it in milliseconds – in this case, you have a full 15 seconds to get



**Figure 5**

your shot arranged perfectly after you press **ENTER**. You can explore more camera options in the next chapter, or by referring to Chapter 17.

## 06 Rotate the image

If the live preview was upside-down, you'll need to tell `raspistill` the camera is rotated. The Camera Module is designed to have the ribbon cable coming out of the bottom edge; if it's coming out of the sides or the top, as with some third-party camera mount accessories, you can rotate the image by 90, 180, or 270 degrees using the `-rot` switch. For a camera mounted with the cable coming out of the top, use the following command:

```
raspistill -rot 180 -o test.jpg
```

## SHOOTING VIDEO

For shooting video, `raspivid` is what you need. Try it out with this Terminal command:

```
raspivid -t 10000 -o testvideo.h264
```

This records a ten-second video (10,000 milliseconds) at the 1920 × 1080 resolution. You can also shoot slow-mo video at 640 × 480 by using:

```
raspivid -w 640 -h 480 -fps 90 -t 10000 -o test90fps.h264
```

You can use VLC to play the videos back – see Chapter 4 for more details.

## Chapter 2

# Precise camera control

Use command-line switches to access a variety of camera options and effects

**S**o, you've connected the HQ Camera or Camera Module to your Raspberry Pi and learned how to take still photos and shoot videos from the command line. Now let's explore the `raspistill` and `raspivid` commands further, including the many switches and options available. We'll also take a look at the `raspiyuv` command, which sends its unencoded YUV or RGB output directly from the camera component to a file.

### 01 Preview mode

When taking stills or shooting video, one of the first things you might want to alter is the preview window that appears by default on the screen. First of all, if it's upside-down, just add `-rot 180` to your `raspistill` or `raspivid` command to rotate it. Also, adding `-hf` and/or `-vf` will flip the image horizontally and/or vertically.

Using the `-p` switch, you can set the window's on-screen position, along with its height and width. The `-p` switch takes four parameters: x co-ordinate, y co-ordinate, width, and height. So, for example:

```
raspistill -o image.jpg -p 20,100,1280,720
```

...would place the preview window's top-left corner at co-ordinate (20,100), with a width of 1280 pixels and height of 720 pixels.

Note that if you only want to see a preview without taking a shot, you can simply omit the `-o image.jpg` part. The `-t` switch sets the duration of the preview: you can set it to 0 to make it stay on screen until you press **CTRL+C**.

If you want a full-screen preview, this is easily achieved using the `-f` switch. The `-op` switch can be used to adjust the preview's opacity, from 0 (invisible) to 255 (solid). If you want to disable the preview window completely, use the `-n` switch.

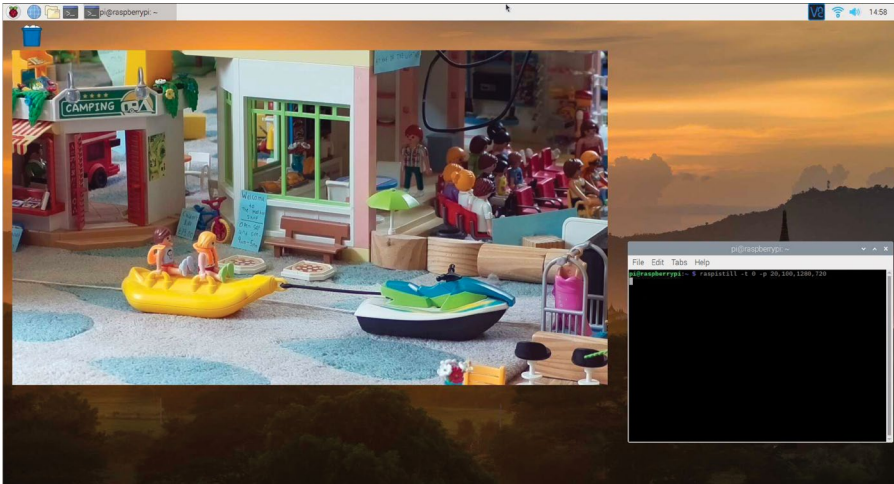

▣ The preview can be resized and positioned manually, and can also have its opacity adjusted

## 02 Camera control options

Like most dedicated digital cameras, the Raspberry Pi HQ Camera or Camera Module offers a range of options to adjust aspects such as brightness (**-br**, from 1 to 100), contrast (**-co**, -100 to 100), sharpness (**-sh**, -100 to 100), saturation (**-sa**, -100 to 100), ISO (-ISO, 100 to 800), and EV compensation (**-ev**, -10 to 10).

In addition, there are numerous options for exposure mode for shooting in certain scenarios, akin to the 'scenes' found on most digital cameras. Just use the **-ex** switch followed by one of the following terms: **auto**, **night**, **nightpreview**, **backlight**, **spotlight**, **sports**, **snow**, **beach**, **verylong** (long exposure), **fixedfps** (for video only), **antishake**, or **fireworks**.

Automatic white balance can be adjusted by following the **-awb** switch with one of: **off**, **auto**, **sun**, **cloud**, **shade**, **tungsten**, **fluorescent**, **incandescent**, **flash**, or **horizon**.

You can set the shutter speed in microseconds with the **-ss** switch; the upper limit depends on the exposure mode and other settings. The metering mode – used for preview and capture – can be set with **-mm** to one of the following: **average**, **spot**, **backlit**, or **matrix**.

There's also the option of restricting the region of interest to only part of the sensor, using **-roi** with parameters for x and y co-ordinates (from top left), width, and height. For example, to set a ROI halfway across and down the sensor, with quarter-size width and height, you'd use: **-roi 0.5,0.5,0.25,0.25**.

## 03 Keypress mode

If you'd like to take a still photo at an exact time, rather than having to wait for the **-t** switch delay time to elapse, keypress mode is your friend. Just add the **-k** switch to your **raspistill** command, then press the **ENTER** key to take the shot: it acts like a shutter button. To exit the procedure, press **X** followed by **ENTER**.

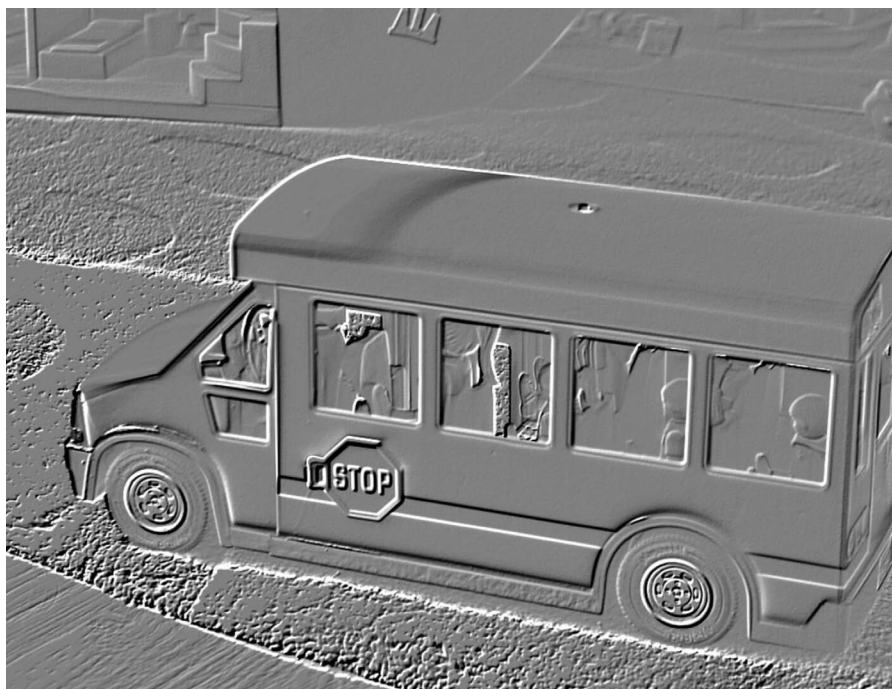

▲ A multitude of real-time effects may be added to images, including emboss, as shown here

By adding `%04d` to the end of your file name in the command, you can save every shot you have taken before aborting:

```
raspistill -o keypress%04d.jpg -k
```

Each shot will have a four-digit sequential number added to its file name, so you'll get **keypress0000.jpg**, **keypress0001.jpg**, **keypress0002.jpg**, etc. This is a useful technique for time-lapses using the `-t1` switch, too: see Chapter 3 for more details.

## 04 Image effects

A whole bunch of effects can be added to the camera in real-time, shown in the preview window. This is achieved by using the `-ifx` switch followed by one of the following terms: **none**, **negative**, **solarise**, **posterise**, **sketch**, **denoise**, **emboss**, **oilpaint**, **hatch**, **gpen** (graphite sketch effect), **pastel**, **watercolour**, **film**, **blur**, **saturation** (adjust colour saturation of the image), **colorswap**, **washedout**, **colorpoint**, **colorbalance**, or **cartoon**.

If you'd like to take monochrome images, you can use the `-cfx` (colour effect) switch to achieve this, using the following setting: `-cfx 128:128`.

To increase contrast between dark and light areas using DRC (dynamic range compression), use the `-drc` switch to turn it on/off (it's off by default).



## 05 Still options

Let's take a look at some options that are specific to the `rastill` command. As already mentioned, we use `-o` followed by a file name to output to a file, and the `-t` switch sets the shutter delay in milliseconds. For example, to save a photo taken after two seconds, use:

```
rastill -t 2000 -o image.jpg
```

You can set the width and height of the image with `-w` and `-h`, each followed by a value – up to 4056 and 3040 (HQ Camera), 3280 and 2464 (Camera Module v2), or 2592 and 1944 (CM v1).

You can also set the quality of the JPEG image, using `-q`, from 0 to 100 – the latter is almost completely uncompressed. Alternatively, to save it as a lossless PNG (slower than using JPG), use `-e` (encoding) followed by `png`:

```
rastill -o image.png -e png
```

For a full list of options, see Chapter 17. The `raspiyuv` command works in a similar fashion and offers most of the same options, apart from adding EXIF tags, but sends its YUV or RGB output directly from the camera component to file. To use RGB, add the `-rgb` switch.

## 06 Shooting video

The `raspid` command is used to shoot video. In this case, the `-t` switch sets the duration in milliseconds. The bitrate is set using `-b`, in bits per second (so, 25Mbps is `-b 25000000`), while `-fps` sets the frame rate – see Chapter 17 for the maximum bitrate and frame rate for your camera model. For example, to shoot five seconds of video at 1080p (1920 × 1080), with a bitrate of 15Mbps and frame rate of 30fps, use:

```
raspid -t 5000 -b 15000000 -fps 30 -o video.h264
```

See Chapter 4 for information on how to shoot slow-motion footage. Many other video options are available, including time delays, keypress mode, and segmenting a stream into multiple files. For full details, see Chapter 17.

- ❑ The posterise effect is shown here; use `-ifx posterise` in your command

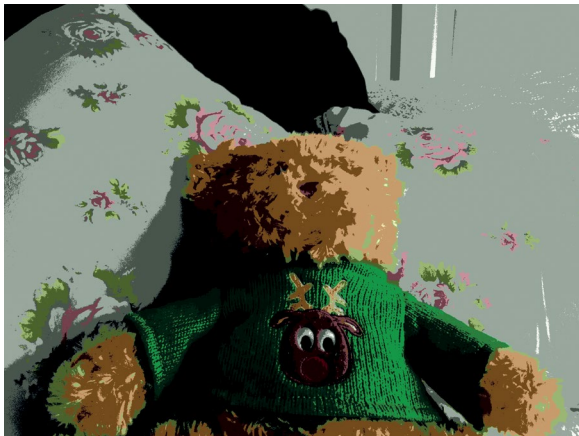

## Chapter 3

# Time-lapse photography

Make a device to capture photographs at regular intervals, then turn these images into a video

**T**ime-lapse photography reveals exciting things about the world which you wouldn't otherwise be able see. These are things that happen too slowly for us to perceive: bread rising and plants growing; the clouds, sun, moon, and stars crossing the sky; shadows moving across the land. In this chapter, we'll be making a Raspbian-based device that lets you watch things that are too slow to observe with the naked eye. To do this, we will capture lots of still photographs and combine these frames into a video with FFmpeg/libav, which can then be accessed via a web browser.



▲ Time-lapse photography is ideal for capturing lengthy natural processes



## 01 Connect the camera

First, with Raspberry Pi turned off, connect the HQ Camera or Camera Module to it with the included ribbon cable. As mentioned in Chapter 1, you need to locate the correct camera socket on your Raspberry Pi, labelled 'CAMERA' (or 'CSI' on some models). Carefully lift up its plastic slider and pull it away from Raspberry Pi gently but firmly; it will move up a short distance, opening up the connector. Insert the ribbon cable into the socket, with the blue side – or white tab on a Raspberry Pi Zero camera cable – facing the plastic slider (and the metal contacts facing the other way). Finally, hold the ribbon cable in position and push the slider back down to clamp the cable firmly in place.

## 02 Enable and test the camera

Power up your Raspberry Pi and enable the camera in the Interfaces tab of the Raspberry Pi Configuration tool (found under Preferences), then reboot your Raspberry Pi.

Open a Terminal window or establish a secure shell (SSH) connection (to access it from a remote computer). You can test the camera by running the following:

```
raspistill -o testimage.jpg
```

After five seconds (if using an original Camera Module v1, its red LED should light up during this time), a JPEG image will be saved to the current directory. If the camera is mounted upside-down, you can use the rotate command-line switch (**-rot 180**) to account for this.

## 03 Install and configure software

Install a web server so you can access your captured images remotely. Run this command to install Apache:

```
sudo apt-get install apache2
```

Remove the default page to see the contents of the directory:

```
sudo rm /var/www/html/index.html
```

Visit the IP address of your Raspberry Pi (e.g. <http://192.168.1.45> – you can find this by using **hostname -I**) on another computer and you should see an empty directory listing. If you run the following command and refresh the page, you should see an image file listed. You run this as a superuser (by using **sudo**) so you can write to the directory.

```
sudo raspistill -o /var/www/html/testimage.jpg
```

Click on the file link on the remote computer and you'll see the image in your browser.



- ▣ Some bread dough ready to prove. Watch it rise in your video. Be careful not to move the bowl or camera during filming

## 04 Capture the images

Set up your scene and check the positioning of the camera.

```
sudo raspistill -w 1920 -h 1080 -o  
/var/www/html/testimageFullHD.jpg
```

The width and height have been changed to capture a smaller image in 16:9 aspect ratio. This makes things easier later. The top and bottom are cropped, so make sure that your subject is in frame. Run this to start the capture:

```
sudo raspistill -w 1920 -h 1080 -t 10800000 -tl 10000 -o  
/var/www/html/frame%04d.jpg &
```

This takes a photo every ten seconds for three hours. The '&' at the end runs the process in the background.

## 05 Prepare to make the video

You can render the video on Raspberry Pi, but – depending on the model – this can take a long time. So you may prefer to

### MAKE AN ANIMATED GIF

Instead of video, make an animated GIF with ImageMagick. Use smaller images, captured less frequently.

```
sudo convert /var/www/frame*.jpg/  
var/www/anim.gif &
```

 OTHER VIDEO FORMATS

WebM is an open video format that can be displayed directly in most browsers. However, other video formats are available.

transfer the files to a more powerful computer instead. Whichever method you decide to use, you will need to install the tools on the rendering machine; for Raspberry Pi, enter:

```
sudo apt-get install libav-tools
```

This installs a fork of FFmpeg, but you can also use the original FFmpeg.

To copy the images to a remote machine, you can download them from the web server using wget or curl. For example:

```
wget -r -A jpg http://192.168.1.45
```

Or if you don't have wget...

```
curl http://192.168.1.45/frame [0001-0766].jpg -O
```

Change the IP address and numbers accordingly.

## 06 Make the video

The final step is to assemble the video. Run the following command to start the rendering process:

```
sudo avconv -i /var/www/html/frame%04d.jpg -crf 4 -b:v 10M /var/www/html/video.webm &
```

When the rendering process has finished, you'll be able to view the video in your browser. The default frame rate is 25fps. This compresses three hours of images taken at ten-second intervals to about 40 seconds of video. You can adjust this with the `-framerate` command-line option. The bitrate (`-b`) has been set high, and the Constant Rate Factor (`-crf`) has been kept low, to produce a good-quality video.

```
pi@raspberrypi ~$ sudo avconv -i /var/www/html/frame%04d.jpg -crf 4 -b:v 10M /var/www/video.webm
[i] 3761
pi@raspberrypi ~$ avconv version 9.14-619.14-1kplrp1, Copyright (c) 2000-2014 the Libav de
built on Jul 22 2014 15:08:12 with gcc 4.6 (Debian 4.6.3-14+rpi1)
Input #0, image2, from '/var/www/html/frame%04d.jpg':
  Duration: 00:00:30.64, start: 0.000000, bitrate: N/A
  Stream #0.0: Video: mjpeg, yuvj420p, 1920x1080, 25 fps, 25 tbn
[libvpx @ 0x1b72e40] v1.1.0
Output #0, webm, to '/var/www/html/video.webm':
  Metadata:
    encoder       : Lavf54.20.4
  Stream #0.0: Video: libvpx, yuv420p, 1920x1080, q=-1--1, 10000 kb/s, 1k tbn, 25 tbc
Stream mapping:
  Stream #0:0 -> #0:0 (mjpeg -> libvpx)
Press ctrl-c to stop encoding
frame= 193 fps= 0 q=0.0 size= 6294kB time=5.32 bitrate=9691.9kbits/s
```

❗ **Running the rendering process on a Raspberry Pi. This will take some time, so you may prefer to use a faster machine**

## Chapter 4

# High-speed photography

All you need to make dazzling slow-motion clips of exciting events is a Raspberry Pi and HQ Camera or Camera Module

**A**t first glance it seems counter-intuitive, but in order to create a smooth slow-motion movie, you need a high-speed camera. Essentially, a movie is just a collection of still photos, or frames, all played one after the other at a speed that matches the original action. A slow-motion clip is produced by recording more frames than are normally needed and then playing them back at a reduced speed. Normal film is typically recorded at 24 frames per second (fps), with video frame rates varying between 25 and 29fps depending on which format/region is involved. So if you record at 50fps and play back at 25fps, the action will appear to be taking place at half the original speed. It's actually a little more complicated than that with the use of interlaced frames, but you don't really need to consider them here.

### Clips can now be recorded at a high frame rate

The original software for the Camera Module was limited in terms of the frame rates it could cope with, but a subsequent update added new functionality so that clips can now be recorded at up to 90fps (or 120fps on the HQ Camera). There is one slight limitation: high frame rates are achieved by combining pixels from the camera sensor, so you have to sacrifice resolution. So, depending on your exact hardware setup, a high-speed mode of 90fps may most consistently be achieved at a lower resolution such as 640×480. This is still good enough to capture decent-quality images, though.

A quick way of getting started is to pick some everyday objects and record them in motion. How about a dropped egg hitting a table top? A pull-back toy car crashing through some Lego blocks? Or even the old favourite of a water balloon bursting? It's best to do the last one outside!

## Pick some everyday objects and record them in motion

Once you've chosen your subject, you'll need a way of holding and angling the camera, and some way of lighting the scene. Neither needs to be sophisticated: a normal desk lamp works fine for extra illumination indoors, while a 'helping-hand' work aid (or tripod) is brilliant for keeping the camera stable at tricky angles. You might also want to invest in a longer cable for the camera. You can get a 30 cm ribbon cable for less than £2 or if you want to go even longer, a set of special adapters allows you to extend using a standard HDMI cable.

## Avoid unwanted reflections, and fine-tune your video specifications

Note that if using a Camera Module v1, its red LED will illuminate when recording is taking place, which can cause undesirable reflections. You can just block the LED off with a blob of modelling clay, or turn it off completely by adding the line `disable_camera_led=1` to your `/boot/config.txt` file. This isn't needed for a Camera Module v2 or HQ Camera.

The command for capturing video with the Raspberry Pi camera is `raspivid`, best run from a Terminal window. There are a number of command options that you need to specify:

- `-fps` sets the frame rate.
- `-w` and `-h` specify the width and height of the frames. For the fastest frame rates, set this to 640 and 480 respectively.
- `-t` allows you to set how long to record for. If you're working by yourself, the easiest way to avoid missing any of the action is to begin filming for a predefined period, giving yourself plenty of time to start things off manually.
- `-o` specifies the file name to use for the saved movie.
- `-n` disables preview mode.

So, putting all of that together, the following commands would capture a five-second clip at 90fps and save the resulting movie in the file `test.h264`:

```
raspivid -n -w 640 -h 480 -fps 90 -t 5000 -o test.h264
```

Right: now that you've recorded your movie clip, how can you play it back? One easy way is to use the free VLC player, which is now installed by default in the full Raspbian 'with desktop and recommended software' image. If it's not, you can install it with:

```
sudo apt-get install vlc
```

The version on Raspberry Pi has some handy features which can be accessed by checking the 'Advanced Controls' option under the View menu. These include the extremely useful 'Frame by Frame' button. You can also alter the playback speed to slow things down even further.



To extend the project, how about connecting a break-beam IR sensor pair via the GPIO pins and using these to trigger the camera recording? The Python picamera library (see Chapter 5) provides full access to the camera's functions and could be used with your code.

## Capturing the clip



### 01 Lights

Get your scene lined up and lit, then test how it looks by using the camera preview mode for five seconds:

```
raspistill -w 640 -h 480 -t 5000
```



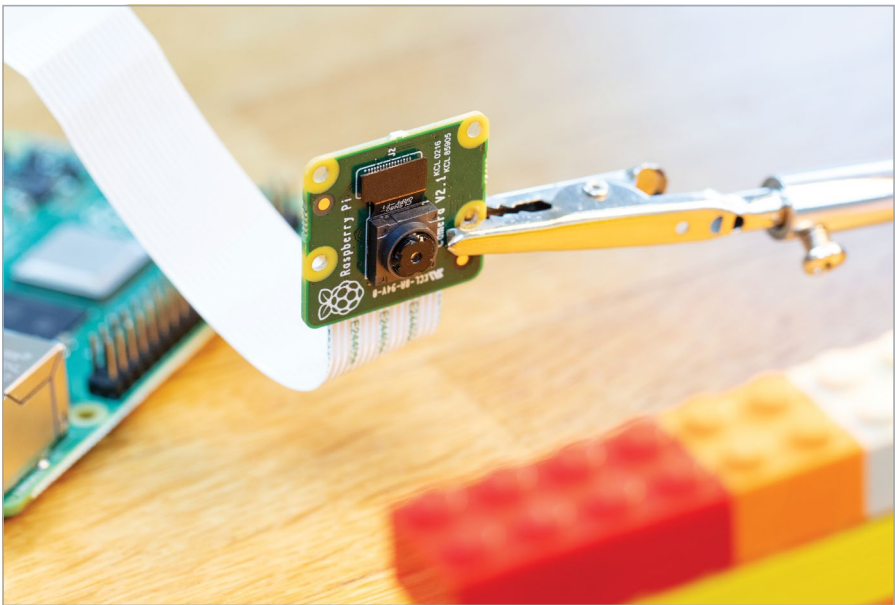
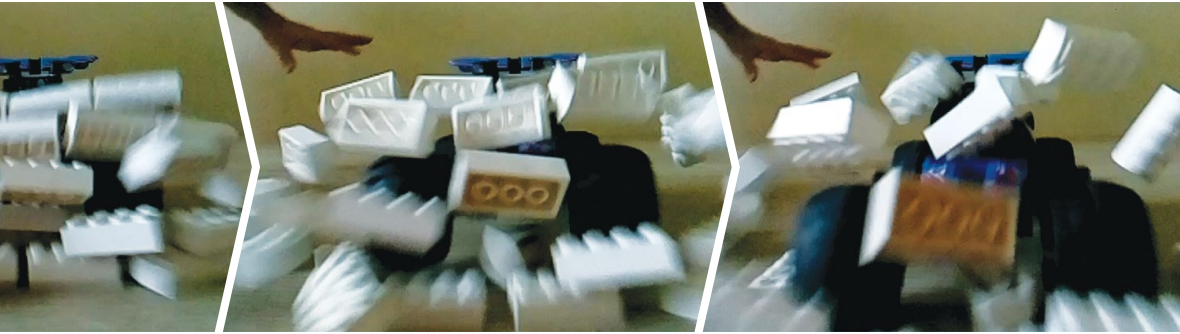

## 02 Camera

Type the command, ready for execution (but don't press **ENTER** yet):

```
raspivid -w 640 -h 480 -fps 90 -t 7000 -o myvid1.h264
```

Once triggered, this will capture a seven-second clip.

## 03 Action

When everything is ready, hit **ENTER** and then release the car / drop the egg / burst the balloon. You'll have footage before and after the event, which can be trimmed with some post-production editing.

## Chapter 5

# Control the camera from Python

Use the picamera library to access the camera in Python programs

**S**o far, we've looked at using the Camera Module or HQ Camera from the command line. This is all very well and good, but what if you want to control it from a Python program? This is where the picamera library comes in, enabling you to access all the camera's features in Python. In this chapter, we'll take a look at how to use it to take stills, shoot videos, alter settings, and add effects.

### 01 Getting started

The picamera library comes pre-installed in the most recent versions of Raspbian. If it's not present already, you can install it manually. In a Terminal window, enter:

```
sudo apt-get update
sudo apt-get install python-picamera python3-picamera
```

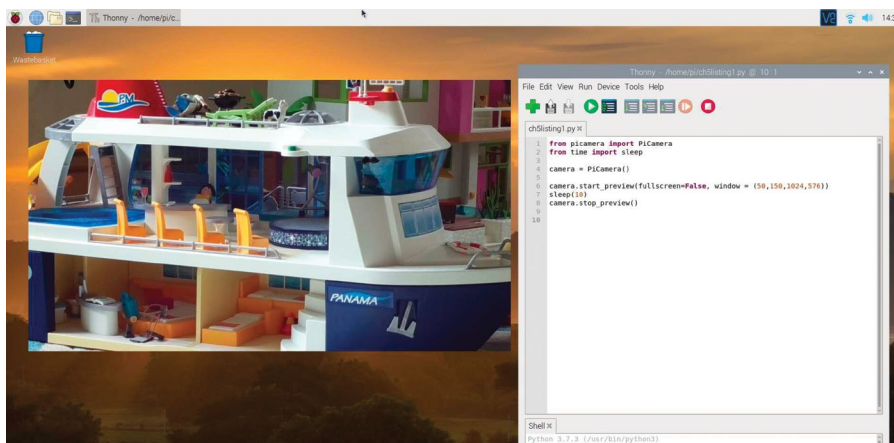

**▲** The camera preview can be resized and positioned to your liking



With your camera already connected and enabled in Raspberry Pi Configuration, open Programming > Thonny from the Raspbian desktop menu. Create a new file by clicking File > New file. Save it with File > Save, naming it **ch5listing1.py**. Note: Never name a file **picamera.py**, as this is the file name for the picamera library itself!

Now enter the code from **ch5listing1.py**. Save it with **CTRL+S** and run with **F5**. The full-screen camera preview should be shown for ten seconds, and then close. Note: To be able to see the preview when using VNC for remote access from another computer, open the VNC Server menu and go to Options > Troubleshooting, then select 'Enable direct capture mode'.

If the preview appears upside-down, add the line **camera.rotation = 180** just above **camera.start\_preview()**. Other possible rotation values are 90 and 270.

You can alter the transparency level of the preview by entering an alpha value – from 0 to 255 – within the latter command's brackets; e.g. **camera.start\_preview(alpha=200)**.

It's also possible to change the position and size of the preview. For example, to place its top corner 50 pixels right and 150 down, and resize it to 1024 × 576:

```
camera.start_preview(fullscreen=False, window = (50,150,1024,576))
```

## 02 Take a photo

Now let's take a still photo. We can do this by adding the line:

```
camera.capture('/home/pi/Desktop/image.jpg')
```

...just after the **sleep** in our code, so it looks like **ch5listing2.py**. Run the code and after a preview of five seconds (as set by **sleep**), it'll capture a photo as **image.jpg**. You may the preview adjust to a different resolution momentarily as the picture is taken. In this example, the resulting image file will appear on the desktop; double-click its icon to open it.

You can alter the file name and directory path in the code, along with the **sleep** time. Remember, though, that it should be at least five seconds, to give the camera sensor enough time to adjust its light levels.

## 03 Make a loop

The great thing about using Python with the picamera library is that it makes it easy to use a loop to take a sequence of photos. In Thonny, create a new file and enter the code from **ch5listing3.py**.

After initiating the camera preview, we add a for loop with a range of 5, so it will run five times to take five photos. The **sleep** command sets the time between shots, captured using the line:

```
camera.capture('/home/pi/Desktop/image%s.jpg' % i)
```

Here, the **%s** token is replaced by whatever we add after the **%** following the file name – in this case, the variable **i** set by our **for** loop. Note that **i** will range from 0 to 4, so the images will

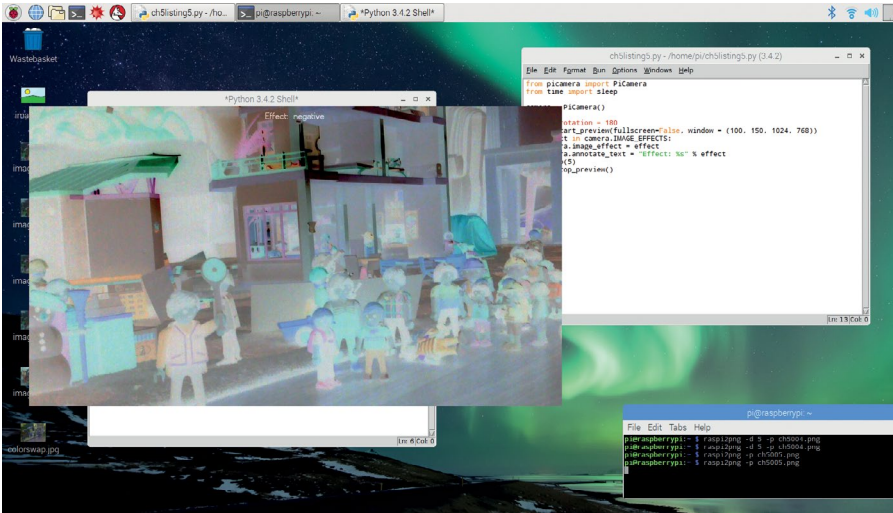

▣ Using the `ch5listing5.py` code, you can view a loop of all the effects on offer

be saved as `image0.jpg`, `image1.jpg`, and so on. Once they're all taken, the preview will close. In this example, you'll see the five files on your desktop; double-click to open them.

You can also use a `for` loop to alter camera setting levels such as brightness over time. For more details, see Step 04.

## 04 Control camera settings

Brightness is just one of numerous settings available for the camera. Here's a list of the main options, along with their default values (and ranges where applicable):

```
camera.brightness = 50 (0 to 100)
camera.sharpness = 0 (-100 to 100)
camera.contrast = 0 (-100 to 100)
camera.saturation = 0 (-100 to 100)
camera.iso = 0 (automatic) (100 to 800)
camera.exposure_compensation = 0 (-25 to 25)
camera.exposure_mode = 'auto'
camera.meter_mode = 'average'
camera.awb_mode = 'auto'
camera.rotation = 0
camera.hflip = False
camera.vflip = False
camera.crop = (0.0, 0.0, 1.0, 1.0)
```

The resolution of the capture is also configurable. For example:

```
camera.resolution = (1024, 768)
```

The maximum resolution for photos is 4056 × 3040 (HQ Camera), 3280 × 2464 (Camera Module v2), or 2592 × 1944 (Camera Module v1). Note: you may need to increase `gpu_mem` in `/boot/config.txt` to achieve full resolution with the Camera Module v2.

## 05 Add image effects

Just as when you are using the command line, a wide range of effects can be added to the camera in real-time, shown in the preview window. The `camera.image_effect` command is used to apply a particular image effect. The options are: `none` (the default), `negative`, `solarize`, `sketch`, `denoise`, `emboss`, `oilpaint`, `hatch`, `gpen` (graphite sketch effect), `pastel`, `watercolor`, `film`, `blur`, `saturation`, `colorswap`, `washedout`, `posterise`, `colorpoint`, `colorbalance`, `cartoon`, `deinterlace1`, and `deinterlace2`.

For instance, to take an image with a colour swap effect, enter the code from `ch5listing4.py` and run it.

To loop through the various image effects in a preview, run the code from `ch5listing5.py`. Note that this uses the `camera.annotate_text` command to add a text message to the preview; this can also be applied to captured images (when using the sensor's full field of view).

For more details on these effects and other settings, see Chapter 17 or the official picamera documentation at [picamera.readthedocs.io](http://picamera.readthedocs.io).

## 06 Shoot a video

To shoot video footage, we replace the `camera.capture()` command with `camera.start_recording()`, and use `camera.stop_recording()` to stop. Enter the example code from `ch5listing6.py`.

When you run the code, it records ten seconds of video before closing the preview. To play the resulting file, open a Terminal window from the desktop and enter:

```
oxplayer video.h264
```

(Or you can use VLC instead.) Note that it may well play faster than the original frame rate. It's possible to convert videos to MP4 format and adjust the frame rate using the MP4Box utility (installed with `sudo apt-get install gpac`), like so:

```
MP4Box -add video.h264:fps=30 video.mp4
```

All of the image effects and most of the camera settings can be applied while shooting video. You can also turn on video stabilisation, which compensates for camera motion, by adding the following line to your Python program:

```
camera.video_stabilization = True
```

## ch5listing1.py / Python 3

 **DOWNLOAD**

```
from picamera import PiCamera
from time import sleep
```

```
camera = PiCamera()
```

```
camera.start_preview()
```

```
sleep(10)
```

```
camera.stop_preview()
```

[magpi.cc/cameragit5](http://magpi.cc/cameragit5)

## ch5listing2.py / Python 3

```
from picamera import PiCamera
from time import sleep
```

```
camera = PiCamera()
```

```
camera.start_preview()
```

```
sleep(5)
```

```
camera.capture('/home/pi/Desktop/image.jpg')
```

```
camera.stop_preview()
```

## ch5listing3.py / Python 3

```
from picamera import PiCamera
from time import sleep
```

```
camera = PiCamera()
```

```
camera.start_preview()
```

```
for i in range(5):
```

```
    sleep(5)
```

```
    camera.capture('/home/pi/Desktop/image%s.jpg' % i)
```

```
camera.stop_preview()
```

### ch5listing4.py / Python 3

```
from picamera import PiCamera
from time import sleep

camera = PiCamera()

camera.start_preview()
camera.image_effect = 'colorswap'
sleep(5)
camera.capture('/home/pi/Desktop/colorswap.jpg')
camera.stop_preview()
```

### ch5listing5.py / Python 3

```
from picamera import PiCamera
from time import sleep

camera = PiCamera()

camera.start_preview()
for effect in camera.IMAGE_EFFECTS:
    camera.image_effect = effect
    camera.annotate_text = "Effect: %s" % effect
    sleep(5)
camera.stop_preview()
```

### ch5listing6.py / Python 3

```
from picamera import PiCamera
from time import sleep

camera = PiCamera()

camera.start_preview()
camera.start_recording('/home/pi/video.h264')
sleep(10)
camera.stop_recording()
camera.stop_preview()
```

## Chapter 6

# Stop-motion and selfies

Wire up a physical push-button to take photos

**H**ave you been reading the last few chapters and thinking you'd like to take a picture with a Raspberry Pi camera with less hassle? In this tutorial we'll show you how to take a photo with a click of a button, just like a real camera. This could be useful for many projects (for example, time-lapse photography), but in this chapter we are focusing on stop-motion animation. We also show how to create your own selfie stick!

### 01 Wire up the button

If you haven't already switched your Raspberry Pi off, do so now. Next, connect the button to Raspberry Pi via a jumper wire, as shown in **Figure 1**. One side of the button will be connected to ground (GND); the other is connected to the GPIO 14 pin (but you can choose your favourite pin). We used a breadboard for our stop-motion animation project, but you could wire the button directly to the pins (as you'll be doing for the selfie stick later).

### 02 Install picamera

That's all the hardware done. Now it's time for the software. If you haven't done so already in Chapter 5, you'll need to install the picamera library. In a Terminal window, enter:

```
sudo apt-get update
sudo apt-get install python-picamera python3-picamera
```

### YOU'LL NEED

- Camera Module / HQ Camera
- Push-button
- Breadboard (optional)
- Jumper wires
- Raspberry Pi case with a hole for the camera cable (selfie stick)
- Long wires (selfie stick)
- A stick, slim metal pole etc. (selfie stick)

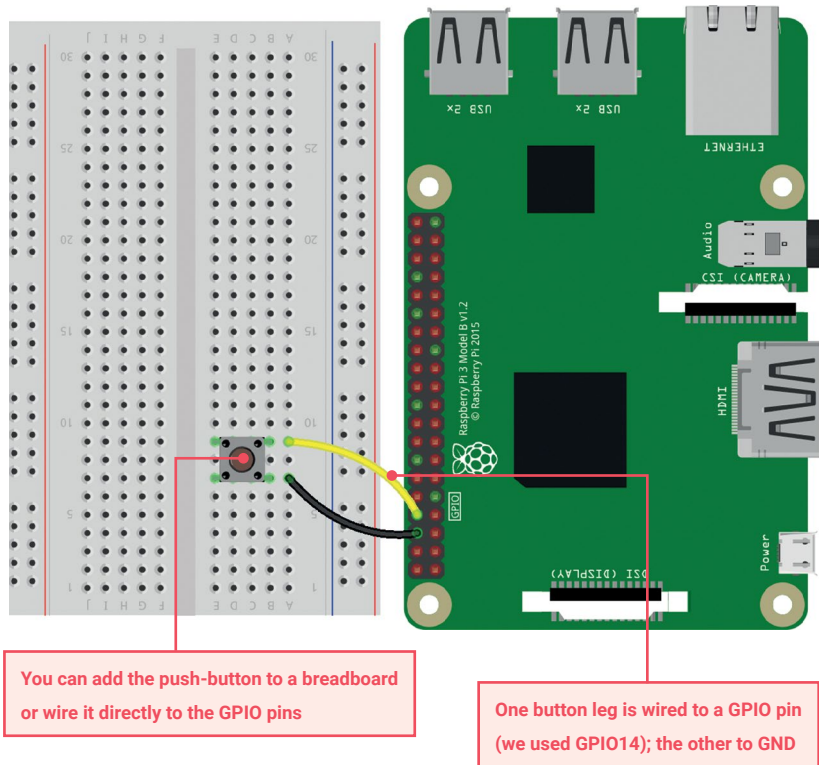

**Figure 1** Connect the button

If for some reason you don't have GPIO Zero already installed (it has come pre-installed in Raspbian for some time), do so with:

```
sudo apt-get install python-gpiozero python3-gpiozero
```

### 03 Stop-motion software

Because we're focusing on stop-motion for our first project, we're using the camera's preview mode so that we can set up our shot before we take it, to ensure everything is in the frame. Then, only when the button is pressed do we save an image file. Each image file will have a different name based on the date and time at which it is taken. This makes it easy to assemble all the images from the shoot for post-processing.

The wonderful GPIO Zero library is used to capture the button activity; we simply define a function that is run whenever the button is pressed. This function uses the picamera Python library which allows us to control the camera through code, making all the normal command-line operations available.

Download or type up the code from **ch6listing1.py** and either run it through Thonny or the command line. To quit the program, press **CTRL+C**.

## 04

### Other variations

You should be able to use this code as a template to create a program for whatever photography project you have in mind. For example, you could alter the code so that the camera takes continuous photos while the button is held down. Or you could add extra buttons to make a variety of photography modes available.

With this sort of build, you can also start thinking about building a complete, portable, wirelessly connected Raspberry Pi camera. For this, you can use a case into which you can fit a portable mobile phone battery charger, along with a screen to attach to Raspberry Pi. With a bit of modification of the code, you can have it always show the preview of the camera on the screen. Want to record video? More modification of the code will allow for video capturing. The only issue you might have with both of these projects is the lack of a flash or built-in light source, so a well-lit subject would be essential.

## 05

### Selfie stick

Next, we'll look at making a selfie stick. A lot of people roll their eyes and complain about vanity when it comes to the art of the selfie, but we all know it's nothing like that. New outfit? New glasses? Eyeliner wings perfectly symmetrical today? Why not chronicle it? It's a great confidence boost.

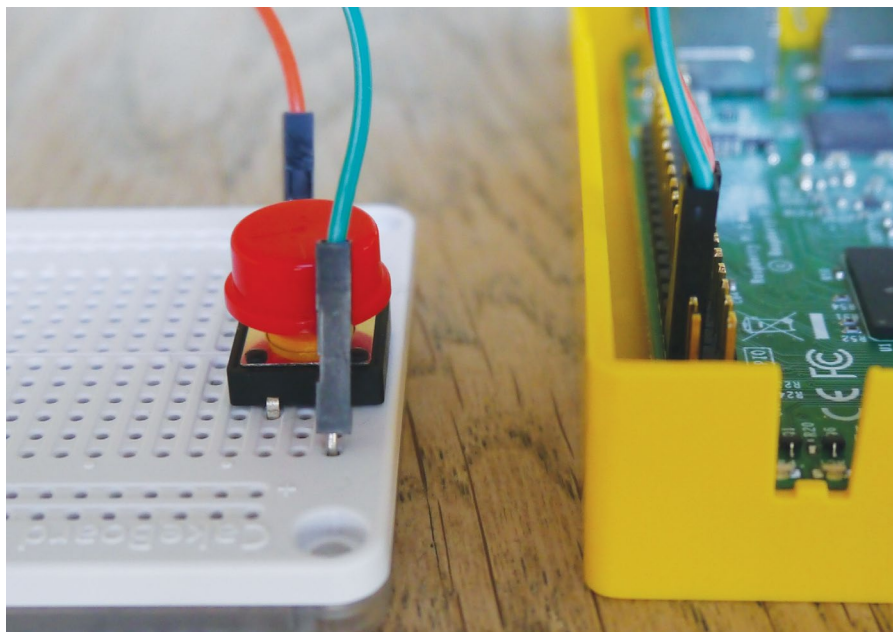

❏ You can use a breadboard for a small button, or connect your jumper wires directly to the pins on a bigger one



**ch6listing1.py** / Python 3 **DOWNLOAD**[magpi.cc/cameragit6](http://magpi.cc/cameragit6)

```
#importing the necessary modules
from datetime import datetime
from gpiozero import Button
import picamera
import time

b=Button(14)
pc=picamera.PiCamera()
running = True
#pc.resolution = (1024, 768)
#use this to set the resolution if you dislike the
default values
timestamp=datetime.now()
def picture():
    pc.capture('pic'+str(timestamp)+'.jpg') #taking the
picture

pc.start_preview() #running the preview
b.when_pressed=picture
try:
    while running:
        print('Active')#displaying 'active' to the shell
        time.sleep(1)
#we detect Ctrl+C then quit the program
except KeyboardInterrupt:
    pc.stop_preview()
    running = False
```



▣ Our test selfie stick is very DIY, but you can use anything as long as you can attach a Raspberry Pi and have a long enough wire



- Create your stop-motion scene and use the button to trigger the camera to take pictures and save them to timestamped file

Our Raspberry Pi-powered selfie stick will use a similar hardware and software setup to the stop-motion animation project. As before, we're wiring up a push-button to GPIO 14 and GND pins on Raspberry Pi, but this time we need to attach the jumpers to longer wires to put the button at the end of the 'stick' – we used a spatula, but anything long will do.

Your Raspberry Pi needs to be near to the camera (unless you've got an extra-long ribbon cable). Attach Raspberry Pi in a case to one end of the stick with whatever means you see fit (glue, adhesive putty, string, etc.) and then attach the button.

## 06 Add the code

Since the principle is the same – pressing a button to take a photo – we can use the same code, **ch6listing1.py**, as for the stop-motion project. This time we don't need the camera preview, so you can comment out the line `pc.start_preview()` if you like, by adding a `#` to the start of it.

Try running the code. Pressing the button will take a photo, but you'll need to practise your aim so you can get yourself in the frame. As before, we add a timestamp to each picture, which helps to organise your pictures later and also results in a slight pause in the code, which at least means you won't take too many pictures with a slip of the button.



## Chapter 7

# Flash photography using an LED

Add an LED flash to shoot images in low light

**T**he Raspberry Pi Camera Module or HQ Camera works really well in good lighting conditions, but what if there's less light available? Here we show you how to set up a simple LED flash, which will be triggered each time you take a photo, using the picamera Python library. We also take a look at how to shoot better images in low light when you are not using a flash.

### YOU'LL NEED

- Camera Module / HQ Camera
- White LED
- Resistor

### 01 Download device tree source

Before we can wire up a flash, we need to configure a GPIO pin to use for it. This will then be triggered each time we capture a still using picamera with the flash mode set to on. To do this, we need to edit the VideoCore GPU default device tree source. First, install device tree compiler with:

```
sudo apt-get install device-tree-compiler
```

Then grab a copy of the default device tree source with:

```
wget https://raw.githubusercontent.com/raspberrypi/firmware/master/extra/dt-blob.dts
```

### 02 Edit the device tree source

Edit the file using your favourite text editor, such as nano:

```
sudo nano dt-blob.dts
```

You'll need to find the correct part of the code for the Raspberry Pi model you're using; for instance, the part for Raspberry Pi 4 is found under `pins_4b` {.

Here you'll find `pin_config` and `pin_defines` sections. In the `pin_config` section, add a line to configure the GPIO pin (we're using GPIO 17) that you want to use for the flash:

```
pin@p17 { function = "output"; termination = "pull_down"; };
```

### 03 Enable flash

Next, we need to associate the pin we added with the flash enable function by editing it in the `pin_define` section. We simply change `absent` to `internal` and add a line with the pin number, so it looks like the following:

```
pin-define@FLASH_0_ENABLE {
    type = "internal";
    number = <17>;
};
```

Note that it's the `FLASH_0` section that you need to alter: `FLASH_1` is for an optional privacy LED to come on after taking a picture, but we won't bother with that.

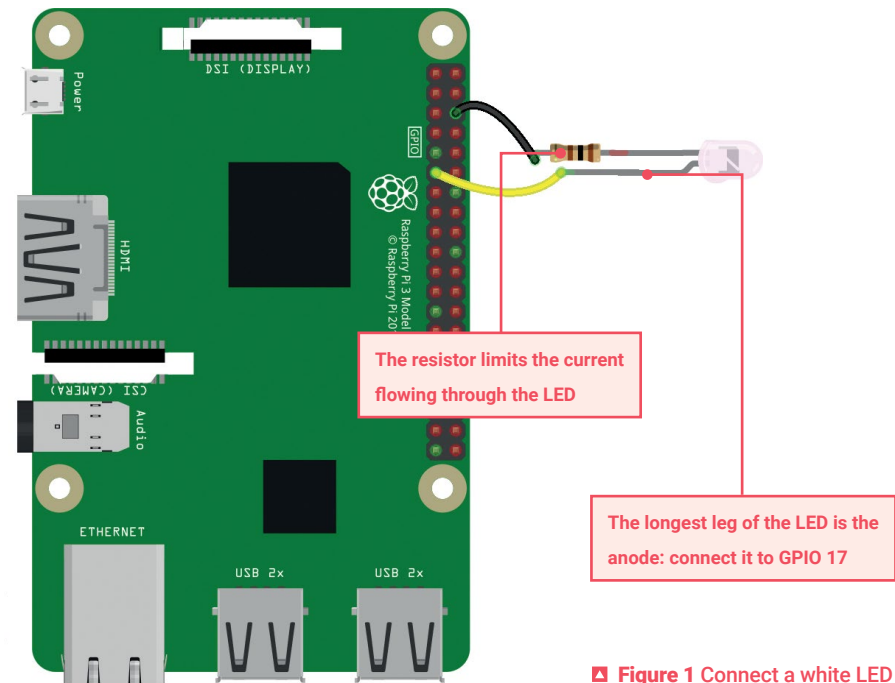

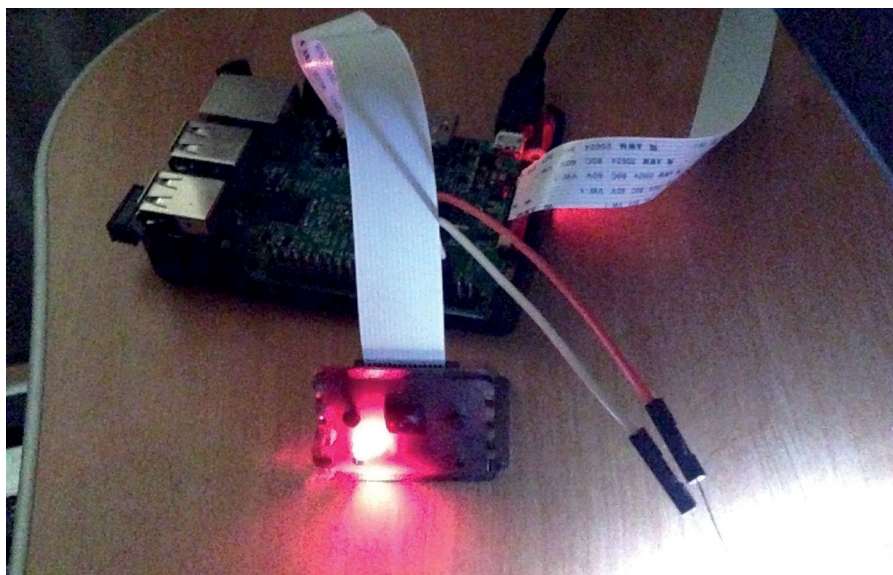

▲ Wire the white LED to GPIO 17 and GND via a low-ohmage resistor

## 04 Compile the blob

With the device tree source updated, we now need to compile it into a binary blob, using the following command in a Terminal window:

```
dtc -q -I dts -O dtb dt-blob.dts -o dt-blob.bin
```

This should output nothing. Next, you need to place the new binary on the first partition of the microSD card. In the case of non-NOOBS Raspbian installs, this is generally **/boot**, so use:

```
sudo cp dt-blob.bin /boot/
```

In you installed Raspbian via NOOBS, however, you'll need to do the following instead:

```
sudo mkdir /mnt/recovery
sudo mount /dev/mmcblk0p1 /mnt/recovery
sudo cp dt-blob.bin /mnt/recovery
sudo umount /mnt/recovery
sudo rmdir /mnt/recovery
```

To activate the new device tree configuration, reboot your Raspberry Pi.

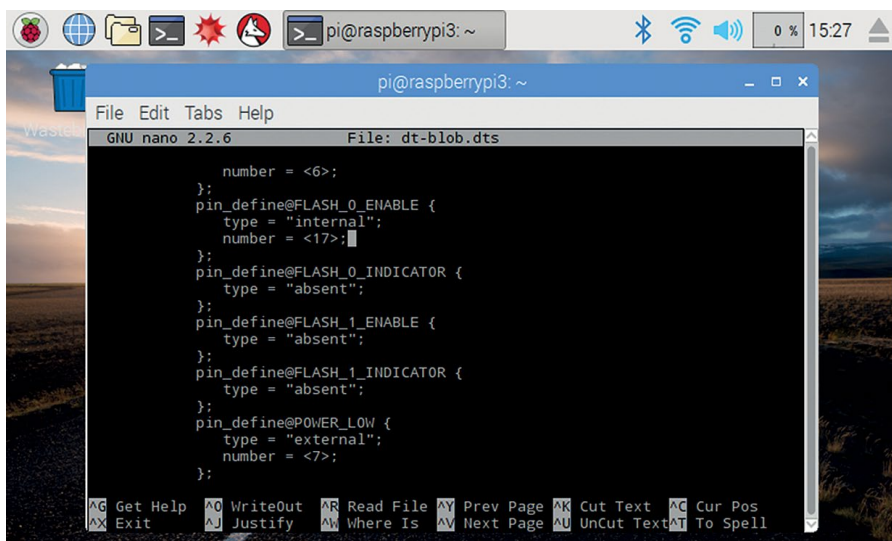

```
File Edit Tabs Help
GNU nano 2.2.6 File: dt-blob.dts
};
pin_define@FLASH_0_ENABLE {
    type = "internal";
    number = <17>;
};
pin_define@FLASH_0_INDICATOR {
    type = "absent";
};
pin_define@FLASH_1_ENABLE {
    type = "absent";
};
pin_define@FLASH_1_INDICATOR {
    type = "absent";
};
pin_define@POWER_LOW {
    type = "external";
    number = <7>;
};
};

^G Get Help ^O WriteOut ^R Read File ^V Prev Page ^K Cut Text ^C Cur Pos
^X Exit ^J Justify ^W Where Is ^N Next Page ^U UnCut Text ^T To Spell
```

■ You need to edit the device tree source to enable a GPIO pin for the flash

## 05 Wire up the LED

Connect a white LED – we used a 5 mm one – to your Raspberry Pi as in **Figure 1** (previous page). The LED’s anode (long leg) is connected to our flash-enabled pin, GPIO 17. To be sure of the LED not burning out from excess current, you should add a low-ohmage resistor (such as 100 Ω) between the LED’s cathode (short leg) and Raspberry Pi’s GND pin. Depending on the maximum forward voltage of your LED (ours was 3.5V), you may be able to get away without using one, but it’s best to be safe.

If you want to use higher-powered or multiple LEDs, you’ll have to think about powering them via a suitable driver circuit, with a transistor wired to the flash pin. You may also need a separate power supply. Note that, due to the Raspberry Pi camera’s rolling shutter, only an LED or equivalent flash is suitable: you can’t use a xenon flash. Alternative flash/lighting methods include NeoPixel sticks and the LISIPAROI light ring.

## 06 Test it out

With the LED connected, we can now test out our flash with a short Python program. In Thonny, create a new file and enter the code from **ch7listing1.py**. The `camera.flash_mode = 'on'` line sets the flash to trigger when we issue the capture command below; the LED will light up briefly before the image capture, to enable the camera to set the correct exposure level for the extra illumination, before the flash proper is triggered.

If you want the flash to trigger automatically only when it’s dark enough, you can change the penultimate line of the code to `camera.flash_mode = 'auto'`.





▲ Using a long exposure, you can shoot stills in very dark settings

## 07 Low-light photography

In low-light scenarios where you don't want to use a flash, you can improve capture of images using a few tricks. By setting a high gain combined with a long exposure time, the camera is able to gather the maximum amount of light. Note that since the `shutter_speed` attribute is constrained by the camera's frame rate, we need to set a very slow frame rate. The code in `ch7listing2.py` captures an image with a six-second exposure time: this is the maximum time for the Camera Module v1 – if you have a v2 Camera Module, it can be extended to ten seconds, or much longer for an HQ Camera. The frame rate is set to a sixth of a second, while we set the ISO to 800 for greater exposure. A pause of 30 seconds gives the camera enough time to set gains and measure AWB (auto white balance).

Try running the script in a very dark setting: it may take some time to run, including the 30-second pause and about 20 seconds for the capture itself. Note: if you're getting a timeout error, you may need to do a full Raspbian upgrade with `sudo apt-get update` and `sudo apt-get dist-upgrade`.

The particular camera settings in this script are only useful for very low light conditions: in a less dark environment, the image produced will be heavily overexposed, so you may need to increase the frame rate and lower the shutter speed accordingly.

If the image has a green cast, you'll need to alter the white balance manually. Turn AWB off with `camera.awb_mode = 'off'`. Then set the red/blue gains manually; e.g. `camera.awb_gains = (1.5, 1.5)`.



▲ Even a single LED can provide illumination for close-up photography



**ch7listing1.py** / Python 3

```
import picamera

with picamera.PiCamera() as camera:
    camera.flash_mode = 'on'
    camera.capture('foo.jpg')
```

 **DOWNLOAD**[magpi.cc/cameragit7](https://magpi.cc/cameragit7)**ch7listing2.py** / Python 3

```
from picamera import PiCamera
from time import sleep
from fractions import Fraction
# Set a framerate of 1/6fps, then set shutter
# speed to 6s and ISO to 800
camera = PiCamera(resolution=(1280, 720),
    framerate=Fraction(1, 6))
camera.shutter_speed = 6000000
camera.iso = 800
# Give the camera a good long time to set gains and
# measure AWB (you may wish to use fixed AWB instead)
sleep(30)
camera.exposure_mode = 'off'
# Finally, capture an image with a 6s exposure. Due
# to mode switching on the still port, this will take
# longer than six seconds
camera.capture('dark.jpg')
```

## Chapter 8

# Make a Minecraft photo booth

Create a photo booth in Minecraft that takes photos of the real world. What will you see on your travels?

**N**ot only is Minecraft Pi great fun to play around with, you can also use Python programming to manipulate the Minecraft world and create various structures within it. Going beyond this, you can even have it interact with the real world. In this chapter, we'll be getting Minecraft to trigger the Camera Module or HQ Camera with code when the player enters a virtual photo booth.

The first thing you need to do is import the Minecraft API (application programming interface). This enables you to connect to Minecraft and program it with Python. You also need to import picamera's PiCamera class to control the camera, and the time module to add a small delay between taking each photo.

Open Minecraft from the applications menu (if it's not present under Games, install it via the Recommended Software tool), then enter an existing world or create a new one. Move the Minecraft window to one side of the screen. You'll need to use the **TAB** key to take your mouse's focus away from the Minecraft window to move it. This will be needed later when you switch between the Minecraft and Python windows.

Open Thonny from the applications menu. This will open up the code editor which you'll use to write the photo booth program.

Enter the code from **ch8listing1.py**, or download it. Save with **CTRL+S** and run the program with **F5**. You should see the message 'Find the photobooth' appear in the Minecraft world. This is the first part of the code. Stop the program running using **CTRL+C**.

## Camera tests

Next, we'll make sure the camera is set up. We've set the camera to show a two-second preview, so that you can strike your pose and smile before the picture is taken. The image is stored as a file called **selfie.jpg** in your home directory (**/home/pi**).



Now, you need to create a photo booth in the Minecraft environment. This is done manually, and the booth can be built wherever you want to locate it. Using any block type, build your photo booth. It can be any shape you like, but it should have at least one block width of free space inside so that the player can enter.

Once you have created your photo booth, you need to be able to move your player inside and onto the trigger block. This is the block that the player stands on to run the function that you wrote in the first step, which will then trigger the camera. In the Minecraft environment, your position is given in reference to the x, y, and z axes. Look at the top-right of the window and you'll see the x, y, and z co-ordinates of your player – for example, 10.5, 9.0, -44.3. Assuming you are still in the photo booth, then these are also the x, y, and z co-ordinates of the trigger block in your booth.

## Walk into your photo booth

Note down all three co-ordinates of your camera trigger block. When you're playing Minecraft, your program will need to verify that you are inside the photo booth. If you are, then it will trigger the `take_the_pic` function and take a picture with the camera. To do this, Minecraft needs to know where you are in the world.



Construct your photo booth however you wish; just make sure the code knows where it lives

Steve is your 'shutter' in the Minecraft world: move him to the booth to take a photo

Place the booth anywhere in your world. Give it a special room in your house, or use it as a trap to see if someone is in your world

To find your position, you use the code `x, y, z = mc.player.getPos()`. This saves the x, y, and z position of your player into the variables `x`, `y`, and `z`. You can then use `print(x)` to print the x value, or `print(x, y, z)` to see them all if you wish, by adding it to the code. Now you know the position of the player, you can test to see if they're in the photo booth.

At this point we have a photo booth, the co-ordinates of the trigger block, and code to control the camera and take a picture. The next part of the code is to test whether the program knows when you're in the photo booth. To do this, we create a loop which checks if your player's co-ordinates match the trigger block co-ordinates. If they do, then you're standing in the photo booth. For this, we use a simple `if` statement, which is known as a conditional.

Change the `if` line in the code to ensure the co-ordinates you enter are those of your photo booth. Save and run your code to test it: walk into your photo booth and you should see the message 'You are in the photobooth!' in the Minecraft window.

You will note that the `if` statement checks if the x value is greater than or equal to 10.5: this is to ensure that it picks up the block, as it could have a value of 10.6. Remember to replace the x, y, and z values with those from your photo booth. After the message is printed, the same preview and camera snap will happen as before the `while` loop. The loop then resets itself so you can enter it again and take another photo!

**ch8listing1.py** / Python 3 **DOWNLOAD**[magpi.cc/cameragit8](https://magpi.cc/cameragit8)

```
from mcpi.minecraft import Minecraft
from picamera import PiCamera
from time import sleep

mc = Minecraft.create()
camera = PiCamera()

mc.postToChat("Find the photo booth")

camera.start_preview()
sleep(2)
camera.capture('/home/pi/selfie.jpg')
camera.stop_preview()

while True:
    x, y, z = mc.player.getPos()

    sleep(3)

    if x >= 10.5 and y == 9.0 and z == -44.3:
        mc.postToChat("You're in the photo booth!")
        sleep(1)
        mc.postToChat("Smile!")
        sleep(1)
        camera.start_preview()
        sleep(2)
        camera.capture('/home/pi/selfie.jpg')
        camera.stop_preview()

    sleep(3)
```

## Chapter 9

# Make a spy camera

Set up a motion-activated spy camera in your room

**W**e've all been there. You've gone out for the day and you know you closed your bedroom door, but you come back and it's slightly ajar. Who's been in there? Were they friend or foe? In this chapter we'll use the Camera Module or HQ Camera as a spy camera that takes a picture when anyone's presence is detected by a passive infrared (PIR) sensor. Here we're using a

Raspberry Pi Zero – which is easier to hide away due to its size – with a special camera cable for it, but you can use any Raspberry Pi model. Unless you want to power it from the mains, you'll also need a portable power supply such as a mobile phone battery pack.

### YOU'LL NEED

- Camera Module / HQ Camera
- PIR sensor [magpi.cc/pir](http://magpi.cc/pir)
- Raspberry Pi Zero camera cable (optional) [magpi.cc/zercamcable](http://magpi.cc/zercamcable)
- Portable power supply (optional)
- Jumper wires

## 01 Getting started

First, connect your Camera Module or HQ Camera to Raspberry Pi. Note that if you're using a Raspberry Pi Zero, you'll need a special adapter cable since its camera connector is smaller: the cable's silver connectors should face the Raspberry Pi circuit board. You'll also need to have enabled the camera in Raspberry Pi Configuration, as explained in Chapter 1.

We'll be using the picamera Python library to trigger our spy camera, so if you haven't yet installed it, open a Terminal window and enter:

```
sudo apt-get update
sudo apt-get install python-picamera python3-picamera
```

## 02 Wire up the circuit

The circuit for this is fairly simple, especially as the PIR does not need a resistor as part of its setup. The PIR comes with three connection pins: VCC, GND, and OUT. If you can't

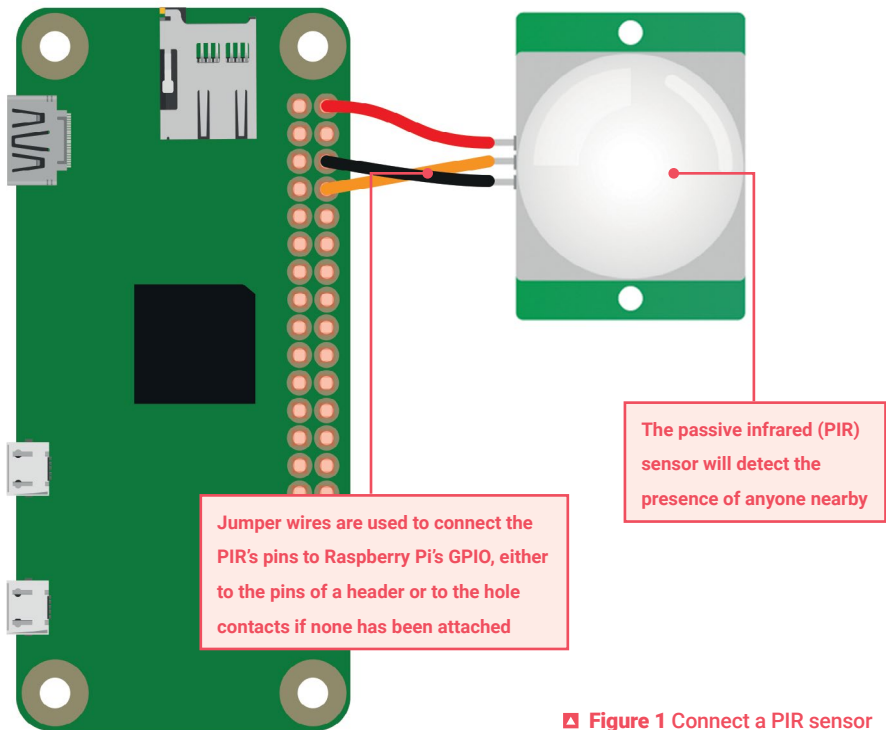

▣ **Figure 1** Connect a PIR sensor

find their labels on the bottom of the sensor, lift off the plastic golf-ball-like diffuser and you should see them on the top of the board. VCC needs to be connected to a 5V power pin, GND needs to go to a ground pin, and then there's the OUT wire which will be our input. We're connecting it to GPIO 14.

If your Raspberry Pi Zero has GPIO pins attached, you can use female-to-female jumper wires to make the connections, as shown in **Figure 1**. Otherwise you can loop the wire around the GPIO holes and use a bit of putty to keep them in place, or a dab of glue from a glue gun on a low setting. Soldering is an option if you want to create a permanent spy camera device.

### 03 Write the code

Now we've got it all wired up, it's time to start coding our spy camera. In the Thonny code editor, create a new file and enter the code from **ch9listing1.py**. This script uses two libraries: GPIO Zero and the standard picamera library. GPIO Zero can be used to get a reading from the PIR motion sensor very easily, which can then be tied into the picamera code so it takes a photo when motion is detected.

At the top, we import **MotionSensor** from GPIO Zero and **PiCamera** from picamera. Since we'll be giving each photo a timestamp, we also import **datetime**, along with **sleep** from the **time** library.



- ▲ Camouflaged against Yoshi, the camera will take candid snaps of anyone who comes close to your game collection

In a never-ending `while True:` loop, we use GPIO Zero's handy `wait_for_motion` function to pause the code until the PIR detects any motion. When it does, we set the photo file name to the current time and date, then take the picture. To enable the PIR to settle, we sleep for five seconds before returning to the top of the loop to wait for motion again.

## 04 Final preparations

You can run the code first to give it a test. You might want to change the sensitivity and/or trigger time, which you can do by adjusting the little orange potentiometer screws on the side of the PIR board: Sx adjusts sensitivity, while Tx alters the trigger time.

Once that's done, we'll get the program to start automatically whenever we boot up the Raspberry Pi. To do so, open up a Terminal window and edit the profile config file with `sudo nano /etc/profile`. To the bottom of the file, add this line:

```
sudo python spy.py
```

In addition, to get Raspberry Pi to boot up slightly faster and, more importantly, to use a little less power so your battery lasts longer, it's best to get it to boot directly to the command line rather than booting to the desktop. The easiest way to change this is to open Preferences > Raspberry Pi Configuration from the desktop; in the default System tab, change Boot to the 'To



**ch9listing1.py** / Python 3 **DOWNLOAD**[magpi.cc/cameragit9](https://magpi.cc/cameragit9)

```
#!/usr/bin/env python
```

```
from gpiozero import MotionSensor
from picamera import PiCamera
from datetime import datetime
from time import sleep

sensor = MotionSensor(14)
camera = PiCamera()

while True:
    sensor.wait_for_motion()
    filename = datetime.now().strftime("%H.%M.%S_%Y-%m-
%d.jpg")
    camera.capture(filename)
    sleep(5)
```

CLI' option. Alternatively, open a Terminal window and enter `sudo raspi-config` to open the Configuration Tool; select Boot Options > Desktop / CLI and option B2 – Console Autologin Text console.

**05** **Hide your camera**

Now you need to find a good place to hide your camera. The default cable for the camera is limited by length, while the PIR can have its wires lengthened, so keep that in mind when building your system. Alternatively, you could get a camera extender ([magpi.cc/camextender](https://magpi.cc/camextender)) to link your cable to a standard-width one. Longer standard-width cables – of up to 2 m – are also available if you are not using a Raspberry Pi Zero.

Hiding your Raspberry Pi and battery behind a plush toy or photo frame can work well (you could even put a dummy photo up and cut a hole in it for the camera to look through). The PIR has quite a wide range, so put it up high where people are unlikely to look.

**06** **Check for intruders**

All you need to do now is plug in the power supply and your Raspberry Pi Zero will turn on and automatically run the script. Do some tests to make sure the camera is facing the right way. Leave it running during the day and then when you get back, plug it into a monitor, stop the script, and run `startx` to get the GUI up. From here you can see the pictures it has taken: crucial evidence to catch your dog or sibling red-handed.

## Chapter 10

# Smart door

Adding a Raspberry Pi to your door has magical results. Want to see who's at the door or know when the post has arrived? Control the lock? Read on...

**Is your door a bore? Open and close, open and close. Snoozefest. Surely it can do more than that?** How about a smart door that knows when someone approaches, when the post arrives, and can even offer remote viewing of the peephole? You can also add intelligent lighting, a controllable door lock, and facial recognition, all powered with your Raspberry Pi. So, let's ignore super-expensive door systems and build our own. You can do as much, or as little, as you like of this project and there's plenty of room for new and inventive uses.

### 01 Prepare your Raspberry Pi

Although you can use any WiFi-capable model, this is a perfect project for the Raspberry Pi 3A+. Start by attaching Raspberry Pi to the Touch Display and preparing a microSD card with the latest Raspbian release. To allow easier access and mounting, we've detached the control board from the back of the screen, taking great care of the ribbon cable. Eventually, they'll be put in a smart 3D-printed case. Now, get your Raspberry Pi set up and make sure to `sudo apt update` && `sudo apt upgrade` before proceeding.

### 02 Attach the camera

We're going to keep an eye on the outside world by replacing the door's peephole with the Raspberry Pi camera. A peep-hole is typically a two-piece barrel that screws together

#### YOU'LL NEED

- Raspberry Pi Touch Display [magpi.cc/touch](http://magpi.cc/touch)
- Camera Module / HQ Camera
- PIR sensor [magpi.cc/pir](http://magpi.cc/pir)
- 2 × Security door contact reed switch [magpi.cc/doorswitch](http://magpi.cc/doorswitch)
- Wired doorbell [magpi.cc/wiredbell](http://magpi.cc/wiredbell)
- PAM8302 amplifier [magpi.cc/pam8302](http://magpi.cc/pam8302)
- Speaker [magpi.cc/3inspeaker](http://magpi.cc/3inspeaker)
- Magnetic access control system [magpi.cc/magneticaccess](http://magpi.cc/magneticaccess)

and can be easily unscrewed from the inside. Remove the barrel and cover the hole with the camera. We're just going to affix this with tape for now; a printed mount will come later. Mount the screen and Raspberry Pi to the door (we used Command Strips), placed so you can attach the camera's ribbon cable to Raspberry Pi once it's shut down. Make sure the camera is enabled in Raspberry Pi Configuration.

### NIGHT IS DARK

If you want the camera to work well at night, you may want to consider a Pi NoIR Camera Module supported with some infrared lighting.

## 03 Footsteps approaching!

The first smart thing our door is going to do is detect someone approaching it. A cheap PIR sensor is perfect for the job. These cool little geodesic domes are triggered by heat and are the same gizmos that you find in motion-sensor lights, switches, and security systems. Connect to Raspberry Pi as shown in **Figure 1**, checking whether you have a 5V or 3.3V sensor. Sensitivity and duration of a 'detection' can be controlled by the two potentiometers on the PIR board. Mount this outside in a suitable location to 'watch' your door.

## 04 Monitor the door and letterbox

We have two magnetic reed switches, the type you find on windows and doors for security systems. They are made up of two parts: the wired part is a reed switch and the unwired a magnet. When the magnet meets the switch, it closes. If we attach the magnet to the door and the switch to the frame, when the door opens, so does the switch. There's no polarity to worry about, so connect one wire to GPIO 26 and the other to the adjacent GND. Repeat for the letterbox using GPIO 19. You may need a breadboard.

## 05 Ding dong!

If we replace the doorbell with our own button, we can take a photo with the Camera Module or HQ Camera when someone presses it and send a notification. Way better. Mount a standard wired doorbell, which after all is just a momentary contact button, to the outside door frame and wire it back to Raspberry Pi using GPIO 13 and an available GND pin. If you're prototyping on a breadboard, a tactile switch will do fine.

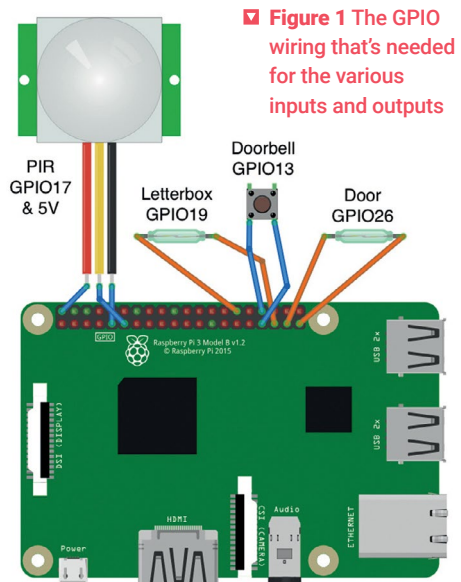



## 06 Sounds good

There's little point in a doorbell that makes no sound. We can use the small, but surprisingly powerful, PAM8302 amplifier with a speaker to make some noise. Supply power by soldering 'Vin' to an available 3V3 pin on Raspberry Pi, and ground to GND. To get an audio signal, you can tap the audio connector's signal and ground, then connect them to A+ and A- respectively. Finally, solder the speaker to the larger + and - terminals. When prototyping, you can skip this and use any active or passive speaker via the audio connector on Raspberry Pi.

## 07 Code

Double-check all your connections and then power up your Raspberry Pi. To use the code published here (overleaf), open a Terminal and enter:

```
mkdir ~/smartdoor
nano ~/smartdoor/smartdoor_test.py
```

Now type in the code as shown. Alternatively, to download all the code:

```
cd
git clone https://github.com/themagpimag/cameraguideCh10
```

To enable it to play our doorbell sample:

```
sudo apt install mpg123
```

Now test with:

```
python3 ~/smartdoor/smartdoor_test.py
```

Watch the console output. If everything is working, you should be able to trigger the PIR, the reed switches, and the doorbell. The camera will capture ten seconds of video when motion is detected, and a photo when the doorbell is pressed. These are both saved to the desktop.

## 08 Get alerts!

Let's make this useful. Install Pushover on your phone, head over to [pushover.net](https://pushover.net), sign up for a trial account, then log in and make a note of your User Key (a long string of characters). Now create a new Application and give it a name. Once created, you'll see an API Token. Make a note of this too. From the GitHub repository, edit `smartdoor.py` and add the User Key and API Token where shown. Run this version and you'll get phone alerts for each event and even a photo attachment when the doorbell is pressed.

## 09 Intelligent porch light

Following on from the Trådfri lighting tutorial in *The MagPi* #75 ([magpi.cc/75](https://magpi.cc/75)), if you have an external porch light, why not make it smart! The file `porch.py` will connect a Trådfri smart light to an API that provides sunrise and sunset times for your location. Leave the script running and the light will switch on and off at the correct times. Additionally, it monitors the

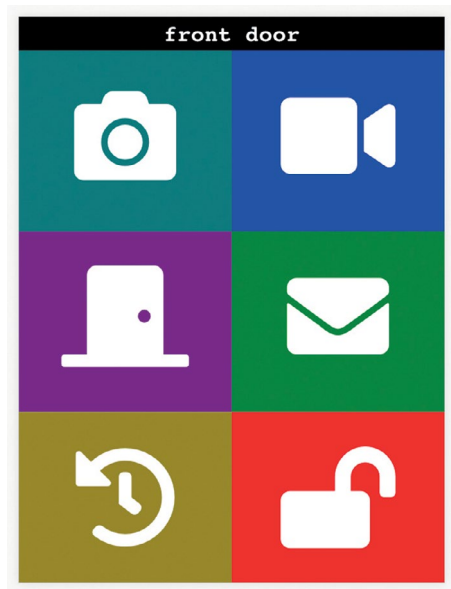

❗ The web app can run on the touchscreen, as well as on mobile devices or desktop browsers. Release the door from anywhere!

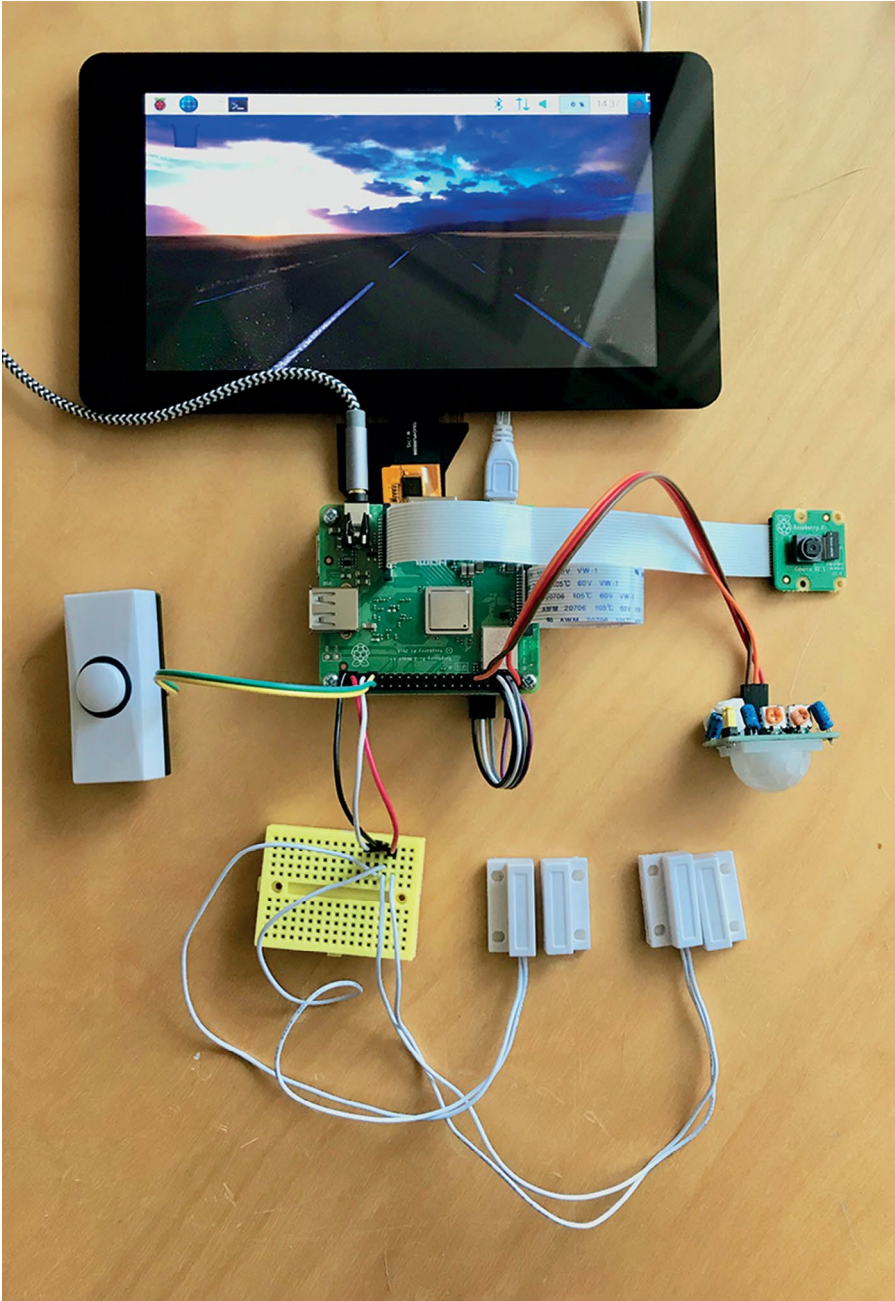

⚠ You may want to prototype this project and test it before taking a drill to your door!

PIR sensor and will switch to full brightness when someone approaches! To use the script, get your latitude and longitude (you can use Google Maps or Earth) and edit **porch.py** as directed in the file.

### GET THE RIGHT LOCK

Magnetic door locks vary in size and shape; measure twice and order once!

## 10 Door lock

If you're interested in being able to control your door's lock, you may see that some solutions are very pricey. One that is perfect for experimentation is the magnetic hold lock, which uses an electromagnet to hold the door closed. The one we've used can withstand 180 kg of force, although stronger ones are available. The magnet mounts on the door and the electromagnet on the frame. The provided PSU contains a relay that can be powered by Raspberry Pi by simply connecting it to a spare GPIO line and ground. Please note this is no replacement for a proper door lock system.

## 11 Web app

It would be great to see what our door has been up to remotely, so a web app seems the next logical step. In the directory called **webapp** is a Python script that uses Flask to provide a web server that is usable on mobile devices. You can take a photo from the peephole, see the last recorded video, and even control the magnetic door lock from Step 10. Simply run the app alongside the others. Better still, set **smartlights.py**, **porch.py**, and **webapp/smartdoor.py** to start on boot (see the repository README).

## 12 Facial recognition

Once a futuristic technology, decent facial recognition is now well within the grasp of Raspberry Pi. Using the doorbell photo taken by Raspberry Pi, we can recognise a face using reference photos and send an alert to Pushover with the name of the caller! In a secure environment, a recognised face could even trigger the lock or you could play a welcome announcement. The install process is a little complicated, so if this interests you, see the documentation in the GitHub repository in the **face\_recognition** directory of the 'smartdoor' repository.

## 13 Over to you

Here we've given you the basics to get going, but more complex events are possible. You could alert different people based on facial recognition or play custom doorbell tones. And, if you had problems with deliveries, video evidence can build up automatically. On a serious note, remember a lot of this is 'just for fun' and designed to inspire, so unless you're prepared to put in the work hardening the code and including failsafes, don't rely on this, or possibly make it as a fun kids' door project (but maybe without the lock!).



## smartdoor\_test.py / Python 3

DOWNLOAD

[magpi.cc/cameragit10](https://magpi.cc/cameragit10)

```
from picamera import PiCamera
from gpiozero import MotionSensor
from gpiozero import Button
from time import sleep
import os
import subprocess
import sys

print('Getting smart...')

# Set up all our devices
camera = PiCamera()
motion = MotionSensor(17)
doorSensor = Button(26)
letterbox = Button(19)
doorbell = Button(13)

def motionDetected():
    print('Motion detected, video recording')
    os.system('DISPLAY=:0 xset s reset') # Wakes the display up
    camera.start_preview()
    camera.start_recording('/home/pi/Desktop/motion.h264')
    sleep(10)

def motionStopped():
    print('Stopping video recording')
    camera.stop_recording()
    camera.stop_preview()

def doorOpen():
    print('Door open')

def doorClosed():
    print('Door closed')

def letterboxOpen():
    print('You got mail!')

def doorbellPressed():
    subprocess.Popen(['mpg123', '/home/pi/smartdoor/doorbell.mp3'],
                    stdout=subprocess.PIPE, stderr=subprocess.STDOUT)
```



**smartdoor\_test.py** (cont.) / Python 3

```
camera.capture('/home/pi/Desktop/doorbell.jpg')
print('Someone\'s at the door!')

# Attach our functions to GPIOZero events
motion.when_motion = motionDetected
motion.when_no_motion = motionStopped
doorSensor.when_pressed = doorClosed
doorSensor.when_released = doorOpen
letterbox.when_released = letterboxOpen
doorbell.when_released = doorbellPressed

print('Smart door is smart')

# Loop forever allowing events to do their thing
try:
    while True:
        pass
except KeyboardInterrupt:
    print('Smart door no longer smart')
except:
    print('Oh dear')
```

## Chapter 11

# Car Spy Pi

Who's that parked on the driveway?  
Find out automatically using ANPR

**A**utomatic number-plate recognition (ANPR) is becoming more and more commonplace. Once the exclusive realm of the police, the technology used to accurately read car number-plates can now be found in supermarket and airport car parks. It wasn't long ago that this technology was extremely expensive to purchase and implement. Now, even a Raspberry Pi has the ability to read number-plates with high accuracy using the Camera Module (or HQ Camera) and open-source software. Let's see what's possible by building a system to detect and alert when a car comes onto the driveway.

### YOU'LL NEED

- Camera Module / HQ Camera
- Suitable outdoor enclosure, e.g. [magpi.cc/rainberry](http://magpi.cc/rainberry)
- Pushover account (optional) [pushover.net](http://pushover.net)

### 01 Pick a spot

First things first: where are we going to put it? Although this project has lots of applications, we're going to see who's home (or not) by reading number-plates of cars coming and going on a driveway. This means our Raspberry Pi is probably going to live outside; therefore, many environmental constraints come into place. You'll need USB 5 V power to your Raspberry Pi and a mounting position suitable for reading plates, although the software is surprisingly tolerant of angles and heights, so don't worry too much if you can't get it perfectly aligned.

### 02 Get an enclosure

As your Raspberry Pi is going to live outside (unless you have a well-placed window), you'll need an appropriate enclosure. For a proper build, get an IP67 waterproof case (e.g. [magpi.cc/ip67kit](http://magpi.cc/ip67kit)). We're opting for homemade, and are using a Raspberry Pi 3 A+ with the RainBerry – a 3D-printable case that, once you add some rubber seals, provides adequate protection. Make sure whatever you choose has a hole for the camera.

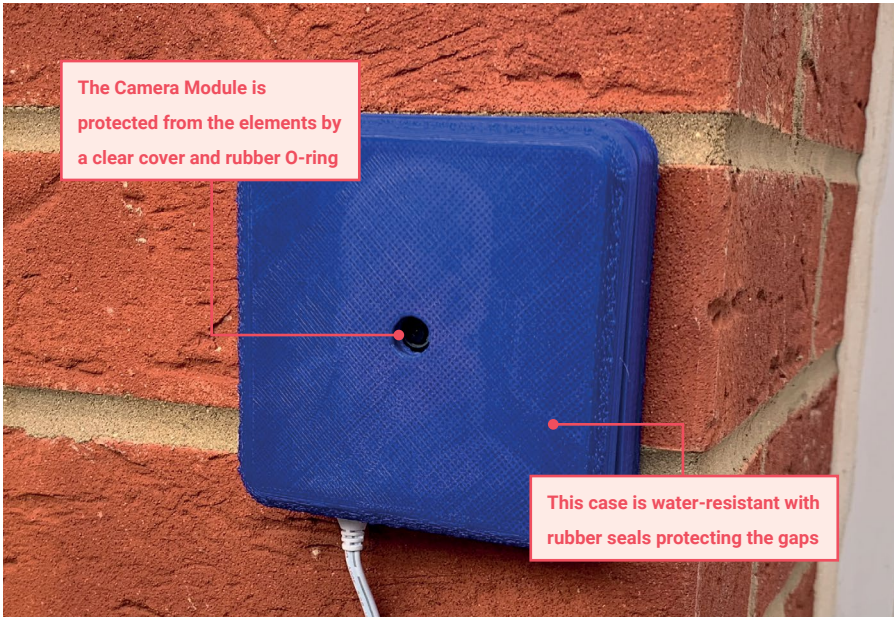

### 03 Prepare your Raspberry Pi

As we don't need a graphical user interface, Raspbian Lite is our operating system of choice. Any Raspberry Pi can handle this task, although if you want the fastest image processing possible, you probably want to avoid the Zero models and get a nice, zippy Model 3B+ or 4. Get your operating system set up, make sure you've done the necessary **sudo apt update && sudo apt -y upgrade** and have configured WiFi if you're not using Ethernet. Finally, make sure your Camera Module (or HQ Camera) is connected and enabled. You can check this by running **sudo raspi-config** and looking under 'Interfacing Options'.

### 04 Install openALPR

Thankfully, we don't need to be experts in machine learning and image processing to implement ANPR. An open-source project, openALPR provides fast and accurate processing just from a camera image. 'ALPR' is not a mistake: this US project is 'Automatic License Plate Recognition'. Thanks to APT, installation is straightforward. At the command line, enter the following:

```
sudo apt install openalpr openalpr-daemon openalpr-utils  
libopenalpr-dev
```

This may take a while, as many supporting packages need to be installed, such as Tesseract, an open-source optical character recognition (OCR) tool. This, coupled with code that identifies a number-plate, is what works the magic.



▲ Protect your Raspberry Pi with a waterproof case

## 05 Time for a test

Once installed, you'll be unceremoniously dropped back to the command prompt. OpenALPR has installed a command-line tool to make testing its capabilities easier and they have also kindly provided a sample image. On the command line, enter the following:

```
cd
wget http://plates.openalpr.com/ea7the.jpg
```

This is a sample USA plate image and a tough one too. Wget grabs the file from the web and places it in your home directory. Let's see if we can recognise it:

```
alpr -c us ea7the.jpg
```

All being well, you'll see a report on screen. The most likely 'match' should be the same as the file name: EA7THE.

## 06 Install Python libraries

We can use openALPR in Python, too. First, install the libraries using pip. If you don't have pip installed, run:

```
sudo apt install python-pip
```

To install the libraries:

```
pip install openalpr picamera python-pushover
```

Now test everything is working by running Python (type `python`) and enter the following code line by line at the `>>>` prompt:

```
import json
from openalpr import Alpr

alpr = Alpr("us", "/etc/openalpr/openalpr.conf",
"/usr/share/openalpr/runtime_data")
results = alpr.recognize_file("/home/pi/ea7the.jpg")
print(json.dumps(results, indent=4))
alpr.unload()
```

If you've not seen JSON-formatted text before, this might seem a bit much, but you should see the correct plate number returned as the first result.

## 07 Get a Pushover token

So that we can get an alert when a car arrives or leaves, we're using old favourite Pushover ([pushover.net](https://pushover.net)), which makes sending notifications to mobile phones a breeze. There's a free trial, after which it's a flat fee of \$4.99 per device, with no subscription or limits. Once logged in, go to 'Your Applications' and make a note of your User Key. Then click 'Create an Application/API Token'. Call it 'ANPR', leave all the other fields blank, and click 'Create Application'. Now make a note of the API Token; you'll need this and the User Key for your code.

## 08 Typing time

Now you have everything you need to create your ANPR application. Enter the code listing shown here or download it from [magpi.cc/cameragit11](https://magpi.cc/cameragit11). Save it as `anpr.py` in your home directory. Edit the file and enter your User and App tokens where prompted. Save the file, then test by entering:

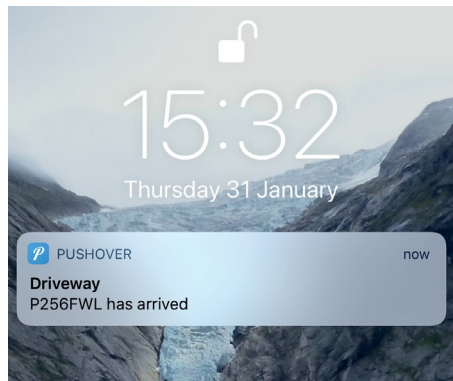

🚩 When a car arrives or leaves our driveway, we receive an alert in seconds

```
python anpr.py
```

The code makes use of the Camera Module (or HQ Camera) and openALPR in tandem. Every five seconds, the camera takes a picture which is passed to openALPR for analysis. If a licence plate is found, we get the number. If there has been a change, an alert is sent to Pushover, which is then forwarded to any registered mobile devices.

## 09 Make your list

If you want to have more friendly names rather than just the plate number, try adding a Python dictionary just after the import statements, like this:

```
lookup = {
    "ABC123": "Steve McQueen",
    "ZXY123": "Lewis Hamilton"
}
```

Then change all instances of `number_plate` in the alert text as follows:

```
lookup[number_plate]
```

Now you'll get a friendly name instead. See if you can handle what happens if the plate isn't recognised.

## 10 Run on boot

A key part of any 'hands-free' Raspberry Pi installation is ensuring that in the event of a power failure, the required services start up again. There are many ways of doing this; we're going use one of the simpler methods.

```
sudo nano /etc/rc.local
```

Find the final line, `exit 0` and enter the following on the line above:

```
#Start ANPR Monitoring
/usr/bin/python /home/pi/anpr.py
```

Press **CTRL+X** then **Y** to save the file. Finally, run the earlier pip command again, using sudo this time to install the libraries for the root user:

```
sudo pip install openalpr picamera python-pushover
```

On reboot, the code will start up and run in the background.





▣ Our target. The software does a great job of recognising number-plates from different heights and angles

## 11 Add logging and curfews

One use of this installation is to track the times cars come and go. This can be especially useful for young drivers who have curfew restrictions on their insurance. See if you can augment the code to check whether a registration plate has not been seen after a certain time. For example, if your younger family members have such a restriction, send them an alert to their phone if their car isn't in the driveway 30 minutes beforehand. You might save them an insurance premium increase! Also, why not log all the comings and goings to a file? A bit of data analysis might help reduce car usage or fuel costs.

## 12 Make it your own

As ever, it's over to you. Now you have the ability to track and record registration plates, there are many different applications for you to explore. Since all the analysis of the image is done locally, no internet connection is required for the system to work. Is there someone 'borrowing' your parking space at work? Catch 'em in the act! Why not take your Car Spy Pi on the road? It could record every vehicle you encounter, which may be useful should something untoward happen. Combine a Raspberry Pi Zero with a ZeroView ([magpi.cc/zeroview](http://magpi.cc/zeroview)) and you're all set.

```
from openalpr import Alpr
from picamera import PiCamera
from time import sleep
import pushover

# Pushover settings
PUSHOVER_USER_KEY = "<REPLACE WITH USER KEY>"
PUSHOVER_APP_TOKEN = "<REPLACE WITH APP TOKEN>"

# 'gb' means we want to recognise UK plates, many
others are available
alpr = Alpr("gb", "/etc/opencv/opencv.conf",
            "/usr/share/opencv/runtime_data")
camera = PiCamera()
pushover.init(PUSHOVER_APP_TOKEN)
last_seen = None

try:
    # Let's loop forever:
    while True:

        # Take a photo
        print('Taking a photo')
        camera.capture('/home/pi/latest.jpg')

        # Ask OpenALPR what it thinks
        analysis = alpr.recognize_file("/home/pi/latest.jpg")

        # If no results, no car!
        if len(analysis['results']) == 0:
            print('No number plate detected')

            # Has a car left?
            if last_seen is not None:
                pushover.Client(PUSHOVER_USER_KEY).send_message(
                    last_seen + " left",
                    title="Driveway")

                last_seen = None

else:
```



**anpr.py (cont.)** / Python 3

```
number_plate = analysis['results'][0]['plate']
print('Number plate detected: ' + number_plate)

# Has there been a change?
if last_seen is None:
    pushover.Client(PUSHOVER_USER_KEY).send_message(
        number_plate + " has arrived",
title="Driveway")
    elif number_plate != last_seen:
        pushover.Client(PUSHOVER_USER_KEY).send_message(
            number_plate + " arrived and " + last_seen +
" left",
            title="Driveway")

    last_seen = number_plate

# Wait for five seconds
sleep(5)

except KeyboardInterrupt:
    print('Shutting down')
    alpr.unload()
```

## Chapter 12

# Build a wildlife camera trap

Uncover the goings-on in your garden, pond, or school playground when no one's looking with this easy-to-use Raspberry Pi camera trap

**E**ver wondered what lurks at the bottom of your garden at night, or which furry friends are visiting the school playground once all the children have gone home?

Using a Raspberry Pi and Camera Module (or HQ Camera), along with Google's Vision API, is a cheap but effective way to capture some excellent close-ups of foxes, birds, mice, squirrels and badgers, and to tweet the results.

Using Google's Vision API makes it really easy to get AI to classify our own images. We'll install and set up some motion detection, link to our Vision API, and then tweet the picture if there's a bird in it. It's assumed you are using a new Raspbian installation on your Raspberry Pi and you have your Raspberry Pi camera set up (see Chapter 1). You will also need a Twitter account and a Google account to set up the APIs.

## Motion detection with Pi-timolo

There are many different motion-detection libraries available, but Pi-timolo was chosen as it is easy to edit the Python source code.

### YOU'LL NEED

- Camera Module / HQ Camera
- Pi NoIR Camera Module (optional)  
[magpi.cc/ircamera](http://magpi.cc/ircamera)
- Waterproof container (like a jam jar)
- ZeroCam NightVision (optional)  
[magpi.cc/zerocamnight](http://magpi.cc/zerocamnight)
- Blu Tack, Sugru, elastic bands, carabiners
- ZeroView (optional) [magpi.cc/zeroview](http://magpi.cc/zeroview)

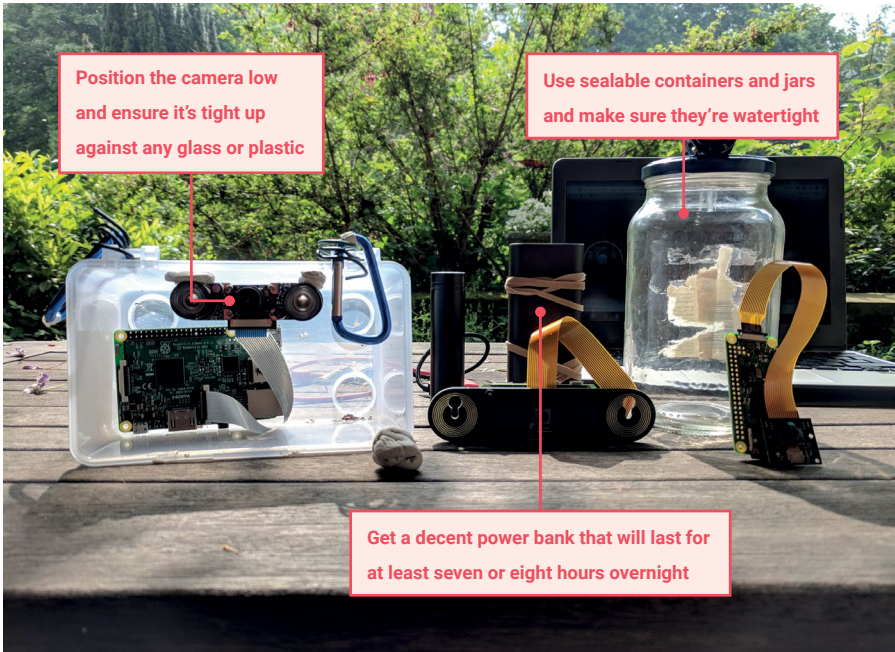

First, make sure Raspbian is up to date. In a Terminal, enter:

```
sudo apt update && sudo apt upgrade
```

Then use the following command to perform an automatic installation of Pi-timolo:

```
curl -L https://raw.githubusercontent.com/pageauc/pi-timolo/master/source/pi-timolo-install.sh | bash
```

Once installed, test it by typing in `cd ~/pi-timolo` and then `./pi-timolo.py` to run the Python script. At this point, you should be alerted to any errors such as the camera not being installed correctly, otherwise the script will run and you should see debug info in the Terminal window. Check the pictures by waving your hand in front of the camera, then looking in Pi-timolo > Media Recent > Motion. You may need to change the image size and orientation of the camera; in the Terminal window, enter `nano config.py` and edit these variables: `imageWidth`, `imageHeight`, and `imageRotation`.

While we're here, if you get a lot of false positives, try changing the `motionTrackMinArea` and `motionTrackTrigLen` variables and experiment with the values by increasing to reduce sensitivity. See the Pi-timolo GitHub repo ([magpi.cc/pitimologit](https://github.com/magpi.cc/pitimologit)) for more details.



## 🚩 Unleash your inner *Springwatch*

There will also be some editing of the `pi-timolo.py` file, so don't close the Terminal window. Code needs to be added to import some Python libraries (`ch12listing1.py`), and also added to the function `userMotionCodeHere()` to check with the Vision API before tweeting (`ch12listing2.py`). We can do this now in preparation of setting up our Google and Twitter API. You should still be in the Pi-timolo folder, so type `nano pi-timolo.py` and add the imports at the top of the file. Next, press **CTRL+W** to use the search option to find the `UserMotionCodeHere()` function and where it's called from. Add the new code into the function (line 240), before the return line. Also locate where the function is being called from (line 1798), to pass the image file name and path. Press **CTRL+X** then **Y** and **ENTER** to save. Next, we'll set up the APIs.

## Animal detection and tweeting

We will be using Google Label Detection, which returns a list it associates with the image. First off, you will need to install the Google Cloud Vision libraries on your Raspberry Pi, so type `pip install --upgrade google-cloud-vision` into your Terminal window. Once finished, run `pip install google-cloud-storage`.

Now you need authorisation. Go [magpi.cc/apiexplorer](https://magpi.cc/apiexplorer) and follow the instructions to create a new project (you may need to log in or create a Google account). Go to the API Dashboard and search for and enable the Cloud Vision API. Then go to API & Services > Credentials, click on Create Credentials and select Service Account from the drop-down. Fill in the details, then click Create. Don't bother to select a Role, just click Continue. Click Create Key and you'll be prompted to download a JSON file. You need this as it contains your service account

key to allow you to make calls to the API locally. Rename and move the JSON file into your **pi-timolo** folder and make a note of the file path. Next, go back to **pi-timolo.py** and add the line: `os.environ["GOOGLE_APPLICATION_CREDENTIALS"] = "path_to_your_.json_credential_file"` below `import os` to reference the credentials in your JSON file.

Finally, set up a Twitter account if you haven't already and install Tweepy by entering `sudo pip install tweepy` into a Terminal window. Once set up, visit [apps.twitter.com](https://apps.twitter.com) and create a new app, then click on Keys and Access Tokens. Edit the code in `userMotionCodeHere()` with your own consumer and access info, labelled as 'XXX' in the code listing. Finally, place your camera in front of your bird feeder and run `./pi-timolo.py`. Any pictures taken of a bird should now be tweeted! If you want to identify a different animal, change the line `if "bird"` in `tweetText: animalInPic = true`.

Please note that although the API works well, it can't always discern exactly what's in the picture, especially if partially in view. It also won't distinguish between types of bird, but you should have more success with mammals. You can test the API out with some of your pictures at [magpi.cc/visionai](https://magpi.cc/visionai) and visit [twitter.com/pibirdbrain](https://twitter.com/pibirdbrain) to see example tweets (scroll down a bit). Good luck and happy tweeting!



📌 Get great photos with night-vision cameras

## ch12listing1.py / Python

DOWNLOAD

[magpi.cc/cameragit12](https://magpi.cc/cameragit12)

```
# add this in at the very top, under
print('Loading ....') along with the other
libraries imported
import io
import tweepy
from google.cloud import vision
from google.cloud.vision import types
from google.cloud import storage
```

## ch12listing2.py / Python

```
# search for userMotionCodeHere.
# There will be 2 results,
# edit the second so you are passing filename to the function
userMotionCodeHere(filename)

# make sure you include filename as a parameter in the function
def userMotionCodeHere(filename):
    # we need to create an instance of the Google Vision API
    client = storage.Client()
    # instantiates a client
    client = vision.ImageAnnotatorClient()

    # loads the image into memory
    with io.open(filename, 'rb') as image_file:
        content = image_file.read()

    image = types.Image(content=content)

    # performs label detection on the image file
    response = client.label_detection(image=image)
    # pass the response into a variable
    labels = response.label_annotations

    # we have our labels, now create a string to add to the text
    # for debugging - let's see what Google thinks is in the image
    print('Labels:')
    # add labels to our tweet text
    tweetText = "Labels: "
```

**ch12listing2.py (cont.)** / Python

```
animalInPic = False
for label in labels:
    print(label.description)
    tweetText = tweetText + " " + label.description
    # edit this line to change the animal you want to detect
    if "bird" in tweetText: animalInPic = True

# set up Tweepy
# consumer keys and access tokens, used for authorisation
consumer_key = 'XXX'
consumer_secret = 'XXX'
access_token = 'XXX'
access_token_secret = 'XXX'

# authorisation process, using the keys and tokens
auth = tweepy.OAuthHandler(consumer_key, consumer_secret)
auth.set_access_token(access_token, access_token_secret)

# creation of the actual interface, using authentication
api = tweepy.API(auth)

# send the tweet with photo and message
photo_path = filename
# only send tweet if it contains a desired animal
if animalInPic:
    api.update_with_media(photo_path, status=tweetText)

return
```

## Chapter 13

# Take your camera underwater

Explore the underwater world with your camera

**T**here are plenty of underwater sports cameras available, but they can be quite expensive, especially if you want to be able to control them remotely. In this chapter we're going to use readily available Raspberry Pi add-ons to make a cheaper, customisable camera unit. There are lots of options and alternative sources of components for a project like this. For example, the Pimoroni Enviro board (or earlier Enviro pHAT) can report back information about the environment in which the camera is operating, especially how much light is available.

### 01 Find a suitable container

To protect the electronics inside it, the container for your Raspberry Pi and camera needs to be watertight and to have at least a see-through lid. You can find food container boxes with a very tight seal, but these tend to be translucent rather than transparent. The size of box will probably determine your choice of Raspberry Pi model and power source. Raspberry Pi Zero W boards are great as they are so small and have built-in wireless LAN. You can also save space by using a LiPo battery instead of a standard power bank (although you'll need a boost regulator too, such as the Pimoroni Zero LiPo).

#### YOU'LL NEED

- Camera Module / HQ Camera
- Python Flask library
- Transparent, waterproof box [magpi.cc/waterproofcase](http://magpi.cc/waterproofcase)
- WiFi dongle (if not using a Raspberry Pi model with built-in wireless LAN)
- Portable power source
- Enviro board (optional) [magpi.cc/enviro](http://magpi.cc/enviro)
- hostapd and dnsmasq packages
- ZeroView (optional) [magpi.cc/zeroview](http://magpi.cc/zeroview)



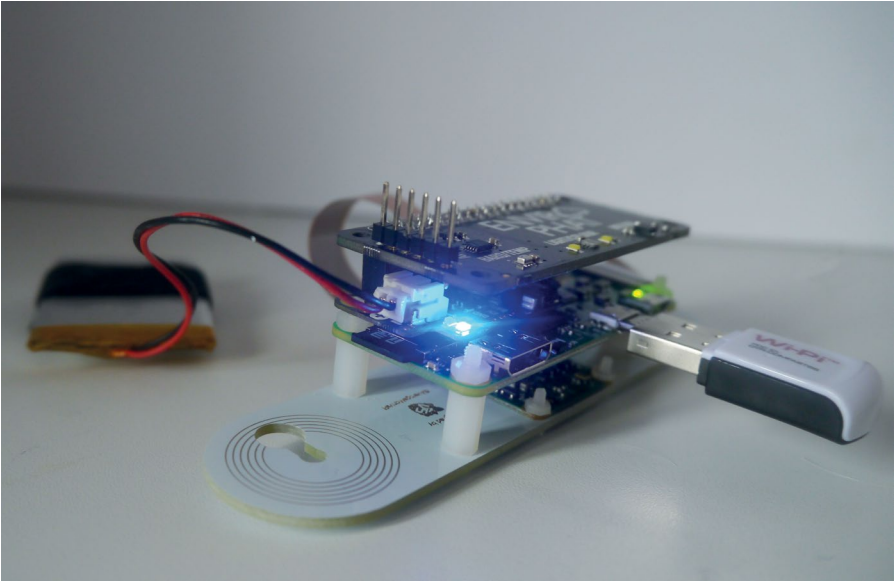

▣ You can save space by using a LiPo battery (via a boost regulator) instead of a power bank

## 02 Set Raspberry Pi as a wireless access point

Start from a fresh Raspbian install on a microSD card. Open up a Terminal window and enter the following commands to update the APT database and install the required packages:

```
sudo apt-get update
sudo apt-get install -y dnsmasq hostapd python3-flask
```

First, since the configuration files aren't ready yet, turn off dnsmasq and hostapd:

```
sudo systemctl stop dnsmasq
sudo systemctl stop hostapd
```

Next, configure your wireless interface to have a static IP address:

```
sudo nano /etc/dhcpd.conf
```

Go to the end of the file and edit it so that it looks like the following (we're using the IP address 192.168.4.1, but you may want to choose a different one):

```
interface wlan0
    static ip_address=192.168.4.1/24
    nohook wpa_supplicant
```



▣ You'll still have to get pretty close to the water yourself

Now restart the `dhcpcd` daemon and set up the new `wlan0` configuration:

```
sudo service dhcpcd restart
```

Next, you need to edit the `/etc/dnsmasq.conf` and `/etc/hostapd/hostapd.conf` files – see [magpi.cc/accesspoint](http://magpi.cc/accesspoint) for details – ensuring that the IP addresses are consistent with your settings in `/etc/dhcpcd.conf`. Then reboot your Raspberry Pi.

### 03 Add the Enviro board

Pimoroni's Enviro board (or the earlier Enviro pHAT, which is still available from some online retailers) enables you to send back environmental data from the camera. With your Raspberry Pi powered off, mount the board on its GPIO header.

Now power up Raspberry Pi and install the Python library and dependencies using the following Terminal commands:

```
git clone https://github.com/pimoroni/enviropius-python
cd enviropius-python
sudo ./install.sh
sudo pip3 install smbus2
```

The Enviro board's library comes with some example programs; you should run some of these to test that everything is working correctly.

Note: If you are not using an Enviro board, you will need to comment out some of the related code in the main **ch13listing1.py** script. If using the Enviro pHAT instead, use the alternative **ch13listing2.py** script in the GitHub repository ([magpi.cc/cameragit13](https://magpi.cc/cameragit13)).

## 04 Fitting everything into your container

To cut down on reflections and obtain the best possible images, the camera should be as close to the transparent side of your container as possible. The ZeroView from the Pi Hut is a clever mounting plate that uses suction cups and will also hold your Raspberry Pi Zero securely. Alternatively, you could make a mount out of cardboard and glue this to the inside of the container. Velcro tape can be a good solution for power sources (which normally need to be removable for recharging).

## 05 Add some code, HTML and CSS

Clone the project's GitHub repository onto Raspberry Pi. In a Terminal window, enter:

```
git clone https://github.com/themagpimag/cameraguideCh13
```

Then use the desktop File Manager to move the Flask folder within **cameraCh13** to your Raspberry Pi's home directory (or use the **mv** command in a Terminal window).

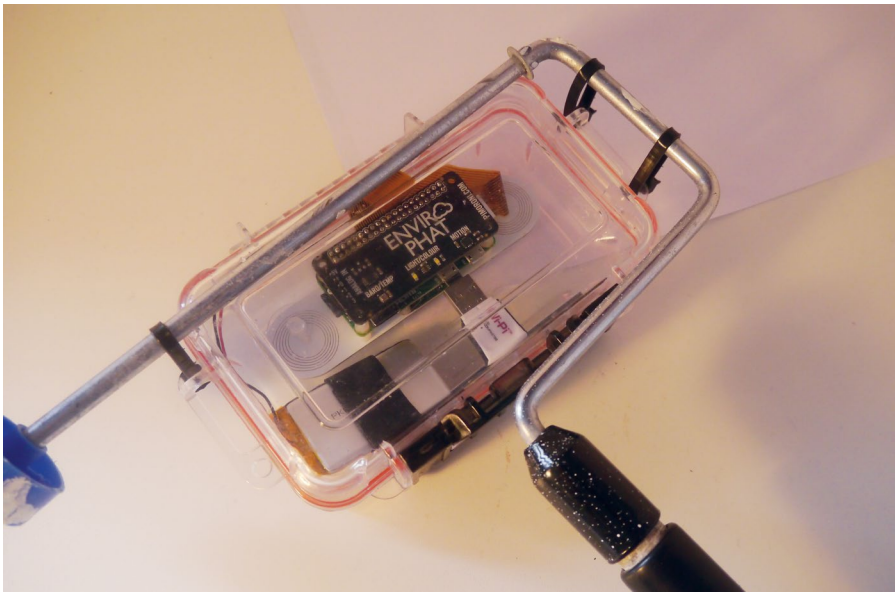

■ A makeshift handle to lower the waterproof box into the water

To run the program, enter the following Terminal command:

```
sudo python3 /home/pi/Flask/ch13listing1.py
```

To see the generated webpage from another computer, you just have to open a web browser and enter your Raspberry Pi's static IP address. Using the on-screen buttons, we can also switch between recording modes (video or continuous still frames) or take photos on demand – by selecting QuickSnap and then clicking the Take button. This control of the camera is achieved via the picamera library, which is used for the three main functions – **timelapse**, **video**, and **snapstart** – defined in our Python script. You could enhance the project by adding additional exposure and shutter speed controls to your interface if you want.

Note: To see the latest image taken, press an on-screen button or reload the webpage.

## 06 Set the code to run at boot

Naturally, we'll want the code to run automatically whenever the Raspberry Pi boots up. To do so, add this line to your `/etc/rc.local` file, immediately above the `exit 0` line:

```
sudo python3 /home/pi/Flask/ch13listing1.py &
```

It is also a good idea to configure your Raspberry Pi to only boot to the command line rather than the desktop, as this uses a little less power and prolongs battery life. The easiest way to change this is to open Preferences > Raspberry Pi Configuration from the desktop; in the default System tab, change Boot to the 'To CLI' option. Alternatively, open a Terminal window and enter `sudo raspi-config` to open the Configuration Tool; select Boot Options > Desktop / CLI and option B2 – Console Autologin Text console.

Now go and find somewhere wet! You might want to run a few tests in the bath before venturing further afield.

- ▣ The web interface shows environmental information and lets you control the camera

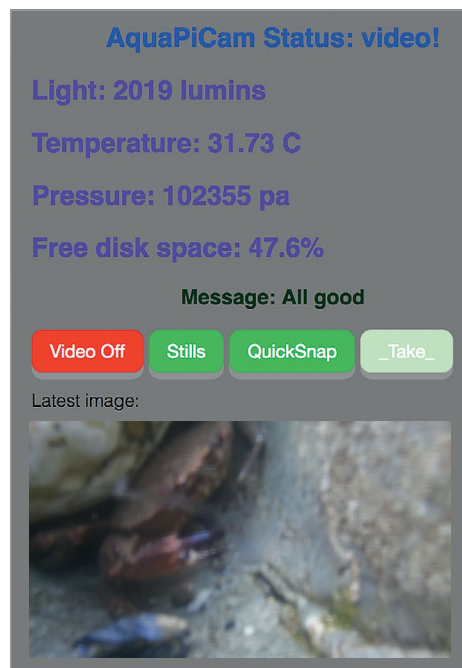

**ch13listing1.py** / Python 3 **DOWNLOAD**[magpi.cc/cameragit13](http://magpi.cc/cameragit13)

```
from flask import Flask, render_template,
request, redirect, url_for
import time, os, shutil
from picamera import PiCamera
from datetime import datetime, timedelta
from threading import Thread
from ltr559 import LTR559
from bme280 import BME280
from smbus2 import SMBus

ltr559 = LTR559()
bus = SMBus(1)
bme280 = BME280(i2c_dev=bus)

app = Flask(__name__)
app.config['SEND_FILE_MAX_AGE_DEFAULT'] = 1

def timelapse(): # continuous shooting
    cam = PiCamera()
    cam.resolution = (1640,922)
    for filename in cam.capture_continuous('img{timestamp:%Y%m%d-
%H%M%S}.jpg'):
        print('snap taken')
        print(btn1,btn2)
        shutil.copyfile(filename, '/home/pi/Flask/static/latest.
jpg')
        if btn1 != 's':
            break
    cam.close()
    print('timelapse thread stopped')

def video(): # record a video
    cam = PiCamera()
    t = '{:%Y%m%d-%H%M%S}'.format(datetime.now())
    cam.resolution = (1920,1080)
    cam.start_recording('vid'+t+'.h264')
    while btn1 == 'v':
        print(btn1,btn2)
        pass
    cam.stop_recording()
    cam.close()
    print('video thread stopped')
```

## ch13listing1.py (cont.) / Python 3

```
def snapstart(): # take pictures on demand
    cam = PiCamera()
    cam.resolution = (1640,922)
    print('entered snapshot mode')
    global btn2
    while btn1 == 'q':
        time.sleep(0.1)
        if btn2 == 'a':
            print('taken snap: btn2 =' + btn2)
            t='{:%Y%m%d-%H%M%S}'.format(datetime.now())
            filename = 'snap'+t+'.jpg'
            cam.capture(filename)
            shutil.copyfile(filename, '/home/pi/Flask/static/
latest.jpg')
            btn2 = 'o'
            print('btn2 =' + btn2)

        cam.close()
        print('exiting snaphot mode')

# we are able to make two different requests on our webpage
# GET = we just type in the url
# POST = some sort of form submission like a button

@app.route('/', methods = ['POST', 'GET'])
def hello_world():

    status = 'off'
    global btn1
    btn1 = 'o'
    global btn2
    btn2 = 'o'
    message = 'All good '

    # if we make a post request on the webpage aka press button
    then do stuff
    if request.method == 'POST':

        # if we press the turn on button
        if request.form['submit'] == 'Video':
```

**ch13listing1.py (cont.)** / Python 3

```
print('BP: Recording video')
status = 'video'
btn1 = 'v'
t2 = Thread(target=video)
t2.start()
message = 'All good'
elif request.form['submit'] == 'Video Off':
    print('BP: Video off')
    status = 'Idle'
    btn1 = 'o'
    message = 'All good'
elif request.form['submit'] == 'Stills':
    print('BP: Recording stills')
    btn1 = 's'
    t1 = Thread(target=timelapse)
    t1.start()
    status = 'stills'
    message = 'All good'
elif request.form['submit'] == 'Stills Off':
    print('BP: stills off')
    status = 'Idle'
    btn1 = 'o'
    message = 'All good'
elif request.form['submit'] == 'QuickSnap':
    print('BP: QuickSnap')
    status = 'Ready to snap'
    btn1 = 'q'
    t3 = Thread(target=snapstart)
    t3.start()
    message = 'All good'
elif request.form['submit'] == 'QuickSnap Off':
    print('BP:QuickSnap off')
    status = 'Idle'
    btn1 = 'o'
    message = 'All good'
elif request.form['submit'] == 'Take':
    print('BP:Take')
    status = 'Snapshot mode'
    btn1 = 'q'
    btn2 = 'a'
    message = 'All good'
elif request.form['submit'] == '_Take_':
```

## ch13listing1.py (cont.) / Python 3

```
        print('BP:Take error')
        status = 'Error'
        message = 'Enable QuickSnap first'
        btn1 = 'o'
    else:
        pass

    temp = round(bme280.get_temperature(),2) # temperature
    press = int(bme280.get_pressure()) # pressure
    lux = ltr559.get_lux() # light levels
    df = os.statvfs('/') # check if we're running out of disk
space
    df_size = df.f_frsize * df.f_blocks
    df_avail = df.f_frsize * df.f_bfree
    df_pc = round(100 -(100 * df_avail/df_size),1)
    print(btn1, btn2)

    # the default page to display will be our template with our
template variables
    return render_template('index2.html', message= message,
status=status, temp=temp, press=press, lux=lux, df_pc=df_pc,
btn1 = btn1)

if __name__ == "__main__":

    # let's launch our webpage!
    # do 0.0.0.0 so that we can log into this webpage
    # using another computer on the same network later
    # specify port 80 rather than default 5000
    app.run(host='0.0.0.0',port=80,debug=True)
```





## Chapter 14

# Install a bird box camera

Observe nesting birds without disturbing them

**W**hile it's simple enough to set up a Camera Module in a weatherproof box to observe wildlife in your garden, for this project we'll be installing a camera inside a bird box. Since it'll be dark inside, and we can't use a standard light source, we'll need to use a Pi NoIR Camera Module. 'NoIR' stands for 'no infrared', as it omits the IR filter found in the standard camera. This enables you to use an infrared light source to see in the dark. Note that we'll need to adjust the fixed focus of the camera by unscrewing the lens.

### YOU'LL NEED

- Pi NoIR Camera Module
- Focus adjustment tool
- Bird box
- IR LED
- Female-to-female jumper wires
- Power source
- Ethernet cable (optional)

### 01 Set up the Pi NoIR

We can't use a standard light source inside the bird box, since this could attract insects and predators, and so would deter any birds from nesting there. So we need to use a Pi NoIR Camera Module (**Figure 1**). Apart from the omission of an infrared filter, this works exactly the same way as the standard camera, so you can connect it up to your Raspberry Pi as in Chapter 1 and use all the same Terminal commands. So, for instance, you can obtain a video preview with:

```
raspivid -t 0
```

You'll notice that everything looks a little strange; this is because you're looking at a combination of visible light and infrared light. To test it out in darkness, turn the lights off, aim

a TV remote control at your face and press the buttons to produce an IR light source. You should see your face illuminated in the darkness. The image will look black and white (greyscale), because there are no wavelengths of light from the visible spectrum being detected. However, a black and white image is good enough to allow you to watch what's happening inside a bird box, and it doesn't disturb or interfere with the birds in any way. Press **CTRL+C** to exit the preview.

## HQ CAMERA

If you want to use an HQ Camera for this project, you'll need to remove its IR filter so it can capture infrared images in the dark. See the leaflet supplied with the camera for more details, but note that this is an irreversible process.

## 02 Wire up an IR LED

We'll need a suitable infrared light source in the bird box. In this example we're using a single IR LED, but alternatives include small IR lamps and the IR version of the LISIPAROI ([lisiparoi.com](http://lisiparoi.com)). Our 890 nm IR LED is an identical component to the ones found inside TV remote controls; the only difference is that we're going to keep it on constantly when shooting video or stills in the bird box.

As usual, you should turn off your Raspberry Pi before connecting anything up. If you've wired up an LED to Raspberry Pi's GPIO pins before, then please note that this LED needs to be done slightly differently. Since an infrared LED requires more current than the GPIO pins can provide, it needs to be connected directly to the 5V supply of Raspberry Pi with a 220  $\Omega$  resistor inline; without the resistor the current will be too high, and the LED will burn out after about ten seconds.

 **Figure 1** The Pi NoIR Camera Module can see in the dark with infrared lighting

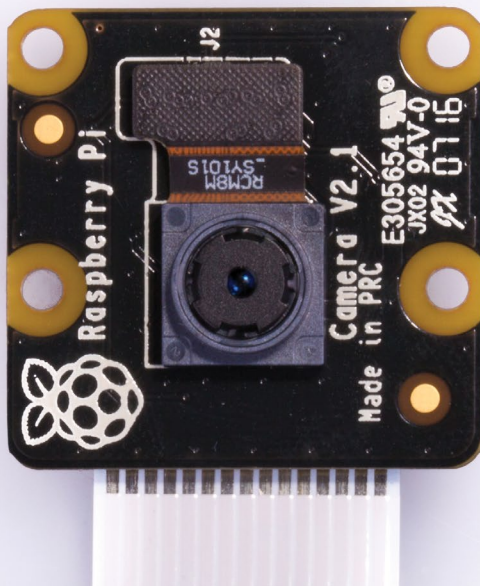

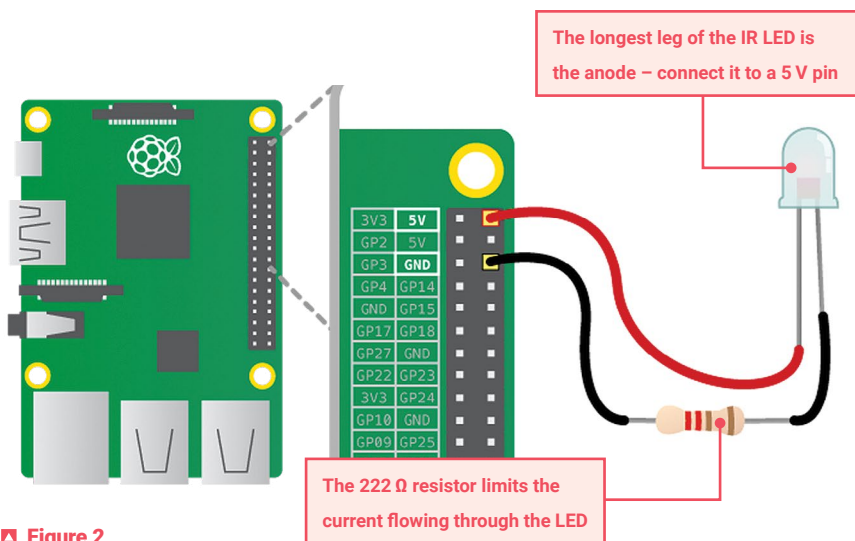

Figure 2

Figure 2 shows how the LED should be wired up. You'll notice that the LED has two legs, one slightly longer than the other. The longer of the two is called the anode and the shorter is the cathode. The LED needs power to flow into the anode and out of the cathode; if you get the polarity wrong then nothing will happen.

Use a couple of female-to-female jumper wires to make the following connections. Connect the anode (long leg) to 5 V, which is the first pin on the outside row on the GPIO. Connect the cathode (short leg) to the 220  $\Omega$  resistor. Connect the other side of the resistor to ground (GND), which is the third pin in on the outside row of the GPIO.

### 03 Test the LED

With everything wired up correctly, turn your Raspberry Pi back on. You'll notice that the infrared LED doesn't appear to be working, but in fact it is. Your human eyes can't see it, but the Pi NoIR camera can. Turn on the camera preview again with `raspivid -t 0`. Hold the LED in front of the camera and you should see it lit. If not, then you may have mixed up the polarity of the anode and cathode. Double-check your wiring against the Figure 2 diagram. Try turning out the lights and aiming the LED at yourself; don't look directly into it, however, as infrared light can still cause harm to your eyes. You'll see from the Pi NoIR camera preview that it will illuminate you quite well. Press **CTRL+C** when you want to exit.

### 04 Adjust focus

By default, the Pi NoIR Camera Module has a fixed focal length of 50 cm and depth of field of 50 cm to infinity. This means that objects will only appear in focus if they're at least 50 cm away from the lens of the camera. The Gardman box we're using in this example has an interior height of 18 cm, so we'll definitely need to shorten the focal length.



**Figure 3** Pinch the lid and then use a pen to mark a cross where your thumb is

Like the standard Camera Module, the Pi NoIR has a lens that can rotate to adjust the focus. If your camera came supplied with a focus adjustment tool (a little plastic wheel), you can use this to turn the lens, removing three blobs of silicone in the process. If you don't have the tool, you could always 3D-print one; there are numerous design available on Thingiverse, e.g. [thingiverse.com/thing:2533691](https://www.thingiverse.com/thing:2533691).

Alternatively, you could always use a scalpel to carefully remove the silicone blobs and then use tweezers to rotate the lens – see [magpi.cc/adjustfocus](https://magpi.cc/adjustfocus) for more details.

Carefully rotate it anticlockwise a few times – be careful not to rotate the lens too far, otherwise it will pop out, and it can be a bit tricky to get it back in and on the thread. If this does happen, just put it back in gently and rotate clockwise until it catches.

Now reconnect the camera to Raspberry Pi. Place an object – such as a watch or business card – in the bottom of the bird box, then remove its roof (remove the screw), hold the camera at the approximate height of the roof, and look at the camera preview. You may wish to put something under the object at this point to simulate the height of a nest, to make doubly sure that the birds will be in focus. Remember that once birds move in, you can't come back and adjust the camera if the focus is wrong.

## 05 Install the camera

Place your finger on the roof, approximately above the centre of the main body of the bird box. Lift up the roof and place your thumb directly below your finger, so that you're pinching the lid as shown in **Figure 3**. Your thumb is now where the camera needs to be. Take a pen and mark this spot with a cross. Cut out a rectangle of cardboard approximately 4 cm × 2 cm (1.5" × 0.75") and fold it in half lengthways. Use some tape to secure it to the underside of the roof so that it's a few millimetres below the cross. This is going to be used to compensate for the angle of the roof, so that the camera points directly into the middle of the bird box.

Next, take the Pi NoIR and slide the flexible cable down between the roof hinge and the back wall of the box – **Figure 4**. Do this with the tin connectors facing away from the back wall. If you wish, you can

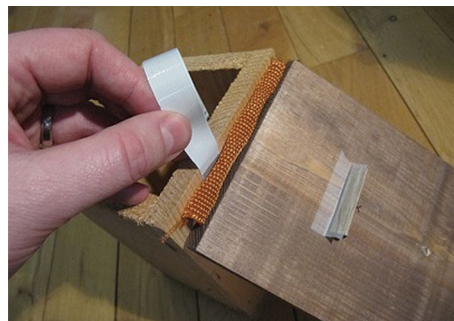

**Figure 4** Slide the camera cable between the roof hinge and the back wall of the box

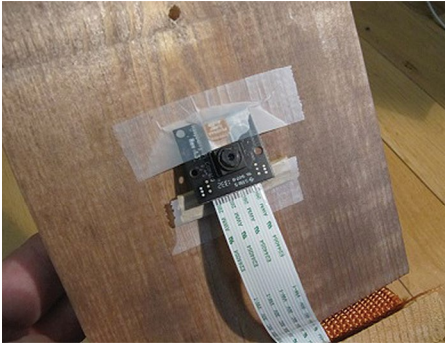

❑ **Figure 5** When in place, the camera should sit at an angle to compensate for the roof slope

remove the two middle staples holding the hinge in place; this will make the flex exit the bird box more neatly.

Take some tape and put it across the top of the Pi NoIR board – do not cover the camera lens! Secure the camera in place so that the central lens is directly over the cross that you drew earlier. The camera should sit at an angle – **Figure 5**. Close the lid and inspect the camera angle from the side: it needs to point directly at the centre of the base. If it doesn't look right, then go back and adjust it until you're happy. An

alternative to taping it in place would be to use the four mounting holes to screw it to the lid via a wedge of wood instead of the cardboard.

## 06 Add the LED

Secure the infrared LED to the underside of the roof. Don't attach it too close to the camera, or you'll see a lot of glare on the video. The LED can go anywhere, but it can help to bend its legs by 90 degrees, as shown in **Figure 6**, and secure it to the roof that way. You may also wish to blank off the end of the LED with correction fluid or by filing it down with a nail file. This will prevent any spotlight effect on the video and give a more diffuse light.

## 07 Test it again

Now reconnect your Raspberry Pi and test the focus once again. We recommend connecting the camera flex coming from the back of the bird box to Raspberry Pi first. Then connect the LED and resistor, followed by the screen, keyboard, and finally the power supply. When testing this setup, it can be helpful to rest Raspberry Pi upside-down on the roof of the bird box, but do whatever works best for you.

Boot up as usual and then start the video preview with `raspivid -t 0`. With the roof of the bird box closed, you should be able to see the inside in black and white. This shows that the infrared illumination is working; you should even be able to cover the hole and still see the inside. It will look similar to **Figure 7**, but will be slightly more zoomed in. This is because this image was taken using the `raspistill` command and not `raspivid`. If you can't see anything at all, then it's likely the LED is not wired

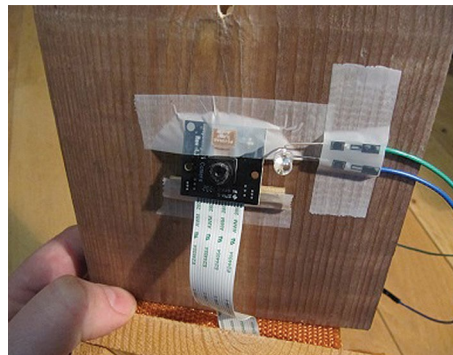

❑ **Figure 6** The IR LED is taped to the underside of the roof, not too close to the camera

up correctly: double-check the wiring and the polarity of the anode and cathode.

It's now helpful to put an object with some black-on-white text into the bird box to verify the focus, such as a watch or business card. Ensure that the text is in focus and readable; adjust the camera focus again as necessary before continuing. Remember to compensate for the nest height. Press **CTRL+C** when you want to stop the camera preview.

### TURN OFF RED LED

If you are using an original (Rev 1.3) Pi NoIR Camera Module, you'll need to disable its red LED that lights up whenever the camera is on. Enter `sudo nano /boot/config.txt` and add the following line to the end of the file: `disable_camera_led=1`. Save and exit the file, then reboot.

## 08 Weatherproof it

While you can attach your Raspberry Pi directly to the outside of the bird box, an alternative is to use a longer camera cable. Either way, you'll need to put Raspberry Pi inside a weatherproof box. Preventing water getting into the bird box should also be a priority. The roof could be sealed using silicone sealant, which is often used to seal the edges of windows and bathroom sinks. Choosing a site which is beneath the overhang of an existing roof will help a lot, so the bird box will not be rained on directly.

Lastly, you need to consider how you will get power and an internet connection to the bird box? You could use a wireless USB dongle, or the built-in wireless LAN of a Raspberry Pi 3 / 3B+ / 4 / Zero W, but Ethernet is more reliable for streaming video, especially in built-up areas that have a lot of wireless traffic.

## 09 Obtain images

With everything installed, connected, and powered up, you can SSH in to your Raspberry Pi from another computer (see [magpi.cc/ssh](http://magpi.cc/ssh) for details) to control it remotely.

You are then able to enter standard Terminal commands such as `raspistill` and `raspivid` to obtain stills (including time-lapses – see Chapter 3) and video footage. You could also write one or more Python scripts using the `picamera` library.



**Figure 7** Make sure that the test object is raised up slightly and the text is in focus

Note that you can't view the live camera preview via SSH. However, you are able to live-stream video from the bird box. This could be achieved using a client-server setup, as described in Chapter 15, to pipe the output to a video player on the client computer. Alternatively, you could make use of an internet video service offering live streaming, such as YouTube (see [magpi.cc/birdboxyt](http://magpi.cc/birdboxyt) for details).

## Chapter 15

# Live-stream video and stills

Stream video and regular stills to a remote computer

**O**ne of the drawbacks of using SSH or VNC to access your Camera Module- or HQ Camera-equipped Raspberry Pi remotely from another computer is that you can't (typically) view the camera preview via these methods. To

get around this, you'll need to stream live video across the network. While there are various methods available for doing this, in this chapter we'll show you how to create a client-server setup for video streaming using the picamera Python library. We'll also explore how to send a stream of stills over the network.



### YOU'LL NEED

- Camera Module / HQ Camera
- Remote computer

## 01 Server-side script

Note: If you are using a Linux-based computer for playback of the video stream, there is an easier method, explained in Step 03.

First, we'll write a Python server script, **ch15listing1.py**, for the remote computer that will read the video stream (which we've yet to write to the code to create) and pipe it to a media player. Note that while you can use a Raspberry Pi 4 for the task of remote playback, earlier Raspberry Pi models won't work in this role since the CPU is not powerful enough to do the video decoding (and neither VLC nor MPlayer supports doing this using the GPU). Therefore you may need to run this script on a faster machine, although even an Atom-powered netbook should be quick enough for the task at non-HD resolutions.

After importing the libraries required at the top of the script, we start listening for connections on 0.0.0.0:8000, i.e. all IP addresses on the local network. We then accept a single connection and make a file-like object out of it.

In the **try:** block, we run a media player from the command line to view it – if you want to use MPlayer instead of VLC, add a **#** to the start of the **cmdline = ['vlc...** line to comment it out, and remove the **#** from the **cmdline = ['mplayer...** line.



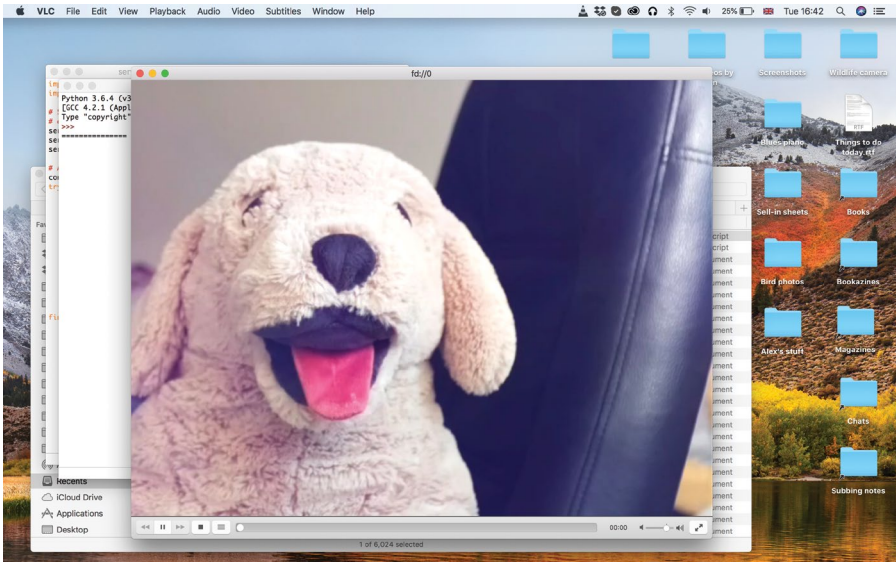

▣ The remote server script reads the video stream and pipes it to a media player, such as VLC

In the `while True:` loop, we repeatedly read 1kB of data from the connection and write it to the selected media player's stdin (standard input) to display it.

Note: If you run this script on Windows or macOS, you will probably need to provide a complete path to the VLC or MPlayer executable/app. If you run the script on macOS, and are using Python installed from MacPorts, please ensure you have also installed VLC or MPlayer from MacPorts.

## 02 Client-side script

Now we'll create a client script, `ch15listing2.py`, on our Raspberry Pi with the Camera Module or HQ Camera equipped. This will connect to the network socket of our server (playback) script to send a video stream to it.

After importing the required libraries at the top, we connect a client socket to `my_server:8000` – you'll need to change `my_server` to the host name of your server (the computer that will play back the stream). If you are using a Linux PC or Mac, just type `hostname -I` in a Terminal window to find it out; in Windows, it's the Computer Name in Control Panel > System.

We then create a file-like object from the network socket before triggering the camera to start recording. In this example we're using a resolution of 640×480 with a frame rate of 24 fps, but you can adjust these numbers to your requirements. We've also set the camera to record for 60 seconds with `camera.wait_recording(60)`; again, you can change this number to suit your preference.



- ▣ An alternative is to set Raspberry Pi as the server and open the network source in VLC or another media player

Run the server script, then the client script. You should see the video stream played in your chosen media player. You may notice some latency; this is normal and due to buffering by the media player.

### 03 Server-side script

As mentioned, if you're using a Linux PC for playback of the video stream, there is a much quicker and easier way to achieve what we've done in Steps 01 and 02. On the server (playback) machine, enter the following command into a Terminal window:

```
nc -l 8000 | vlc --demux h264 -
```

Then, on the client – your Raspberry Pi with the Camera Module or HQ Camera – issue the following command:

```
raspivid -w 640 -h 480 -t 60000 -o - | nc my_server 8000
```

...replacing `my_server` with the server's host name.

### 04 Switch it around

An alternative method is to reverse the direction so that Raspberry Pi acts as a server. We can then get it to wait for a connection from the client before streaming video. Enter the **ch15listing3.py** example on Raspberry Pi and run it.

The big advantage of this method is that you then only need to use a single command to initiate playback on the remote computer:

```
vlc tcp/h264://my_pi_address:8000/
```

...replacing `my_pi_address` with your Raspberry Pi's IP address (again, discovered using `hostname -I`). Or, in VLC running on the desktop, go to File > Open Network and enter the same address: `tcp/h264://my_pi_address:8000/`

## 05 Stream stills

Now let's stream camera stills taken at regular intervals in a variation on a standard time-lapse setup. Entered on a remote computer (which could be another Raspberry Pi), the server script, `ch15listing4.py`, starts a socket to listen for a connection from your Raspberry Pi with the camera. At the top, we import the required libraries; here we're using PIL (you can install it using `sudo pip install pillow`) to read JPEG files, but alternatives include OpenCV and GraphicsMagick. The script then checks the image length and, if it is not zero, constructs a stream to hold the image data and then reads it from the connection. The `image.show()` command will open each image in the default image viewer: it can create a lot of windows if left going for a while! Now to create a client script...

## 06 Stills client script

On your Raspberry Pi with the camera, the client script, `ch15listing5.py`, sends a continual stream of images to the server. We'll use a very simple protocol for communication: first, the length of the image will be sent as a 32-bit integer (in little-endian format), then this will be followed by the bytes of image data. If the length is 0, this indicates that the connection should be closed as no more images will be forthcoming. As before, for connecting the socket, you should replace `my_server` in the script with the host name of the remote computer. We then make a file-like object out of the connection. Before constructing the stream, we start a preview to let the camera warm up for two seconds. Further down, the line `if time.time() - start > 30`: limits the streaming period to 30 seconds, though you can alter this.

Note that the server script should be run first to ensure there's a listening socket ready to accept a connection from the client script.

Taking it further, you may want to add a way of closing each image window before the next is generated. Also, rather than simply showing the images, you could use the numerous functions of PIL to process them (see [effbot.org/imagingbook](http://effbot.org/imagingbook)).

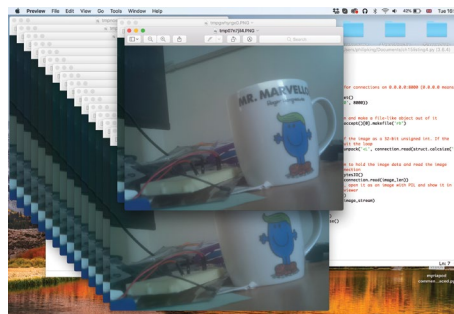

Multiple stills are streamed to the remote computer and displayed

## ch15listing1.py / Python 3

```
import socket
import subprocess
# Start a socket listening for connections on 0.0.0.0:8000
# (0.0.0.0 means all interfaces)
server_socket = socket.socket()
server_socket.bind(('0.0.0.0', 8000))
server_socket.listen(0)
# Accept a single connection and make a file-like object out of it
connection = server_socket.accept()[0].makefile('rb')
try:
    # Run a viewer with an appropriate command line. Uncomment
    the mplayer
    # version if you would prefer to use mplayer instead of VLC
    cmdline = ['vlc', '--demux', 'h264', '-']
    #cmdline = ['mplayer', '-fps', '25', '-cache', '1024', '-']
    player = subprocess.Popen(cmdline, stdin=subprocess.PIPE)
    while True:
        # Repeatedly read 1k of data from the connection
        # and write it to the media player's stdin
        data = connection.read(1024)
        if not data:
            break
        player.stdin.write(data)
finally:
    connection.close()
    server_socket.close()
    player.terminate()
```

## ch15listing2.py / Python 3

```
import socket
import time
import picamera

# Connect a client socket to my_server:8000
# (change my_server to the hostname of your server)
client_socket = socket.socket()
client_socket.connect(('my_server', 8000))
```

**ch15listing2.py (cont.)** / Python 3 **DOWNLOAD**[magpi.cc/cameragit15](https://magpi.cc/cameragit15)

```
# Make a file-like object out of the
connection
connection = client_socket.makefile('wb')
try:
    camera = picamera.PiCamera()
    camera.resolution = (640, 480)
    camera.framerate = 24
    # Start a preview and let the camera warm up
    camera.start_preview()
    time.sleep(2)
    # Start recording, sending the output to the connection for 60
    # seconds, then stop
    camera.start_recording(connection, format='h264')
    camera.wait_recording(60)
    camera.stop_recording()
finally:
    connection.close()
    client_socket.close()
```

**ch15listing3.py** / Python 3

```
import socket
import time
import picamera

camera = picamera.PiCamera()
camera.resolution = (640, 480)
camera.framerate = 24

server_socket = socket.socket()
server_socket.bind(('0.0.0.0', 8000))
server_socket.listen(0)

# Accept a single connection and make a file-like
# object out of it
connection = server_socket.accept()[0].makefile('wb')
try:
```

### ch15listing3.py (cont.) / Python 3

```
camera.start_recording(connection, format='h264')
camera.wait_recording(60)
camera.stop_recording()
finally:
    connection.close()
    server_socket.close()
```

### ch15listing4.py / Python 3

```
import io
import socket
import struct
from time import sleep
from PIL import Image

# Start a socket listening for connections on 0.0.0.0:8000
# (0.0.0.0 means all interfaces)
server_socket = socket.socket()
server_socket.bind(('0.0.0.0', 8000))
server_socket.listen(0)

# Accept a single connection and make a file-like object out of it
connection = server_socket.accept()[0].makefile('rb')
try:
    while True:
        # Read the length of the image as a 32-bit unsigned int.
        # If the length is zero, quit the loop
        image_len = struct.unpack('<L', connection.read(struct.
calcsize('<L')))[0]
        if not image_len:
            break
        # Construct a stream to hold the image data and read the image
        # data from the connection
        image_stream = io.BytesIO()
        image_stream.write(connection.read(image_len))
        # Rewind the stream, open it as an image with PIL
        # and show it in the default image viewer
        image_stream.seek(0)
```

### ch15listing4.py (cont.) / Python 3

```
        image = Image.open(image_stream)
        image.show()
finally:
    connection.close()
    server_socket.close()
```

### ch15listing5.py / Python 3

```
import io
import socket
import struct
import time
import picamera

# Connect a client socket to my_server:8000
# (change my_server to the hostname of your server)

client_socket = socket.socket()
client_socket.connect(('my_server', 8000))

# Make a file-like object out of the connection

connection = client_socket.makefile('wb')
try:
    camera = picamera.PiCamera()
    camera.resolution = (640, 480)
    # Start a preview and let the camera warm up for
    camera.start_preview()
    time.sleep(2)

    # Note the start time and construct a stream to
    # hold image data temporarily (we could write it
    # directly to connection but in this case we want
    # to find out the size of each capture first to keep
    # our protocol simple)

    start = time.time()
    stream = io.BytesIO()
```

## ch15listing5.py (cont.) / Python 3

```
for foo in camera.capture_continuous(stream, 'jpeg'):  
  
    # Write the length of the capture to the stream  
    # and flush to ensure it actually gets sent  
  
    connection.write(struct.pack('<L', stream.tell()))  
    connection.flush()  
  
    # Rewind the stream and send the image data over the wire  
  
    stream.seek(0)  
    connection.write(stream.read())  
  
    # If we've been capturing for more than 30 seconds, quit  
  
    if time.time() - start > 30:  
        break  
  
    # Reset the stream for the next capture  
  
    stream.seek(0)  
    stream.truncate()  
  
    # Write a length of zero to the stream to signal we're done  
  
    connection.write(struct.pack('<L', 0))  
finally:  
    connection.close()  
    client_socket.close()
```





## Chapter 16

# Set up a security camera

Protect your home using motionEyeOS

**T**he specialist motionEyeOS distro turns your Raspberry Pi and Camera Module or HQ Camera into a fully fledged security camera that can stream a live view, detect motion, and capture video and stills. In this chapter we'll show you how to install it, get started using it, and even send custom push notifications to your phone when motion is detected!



### YOU'LL NEED

- Camera Module / HQ Camera
- motionEyeOS
- Pushover app
- Remote computer

01

## Install motionEyeOS

motionEyeOS is a Linux distribution that turns a single-board computer into a video surveillance system. To see the list of supported devices and download the relevant distro image, go to [magpi.cc/motioneyeoslist](https://magpi.cc/motioneyeoslist). Note that there are four different versions available for Raspberry Pi, so make sure you download the correct one for your model.

With the image downloaded, you can write it to a microSD card in a similar fashion to Raspbian, by using the Raspberry Pi Imager tool ([magpi.cc/imager](https://magpi.cc/imager)) for example. However, motionEyeOS's creator provides a write utility for Linux and macOS. The advantage of using this is that you can preconfigure the wireless network connection so that you don't have to connect Raspberry Pi to your router via Ethernet at first. This is particularly useful if you are using a Raspberry Pi Zero, which lacks an Ethernet port. To download the utility and make it executable, enter the following commands in a Terminal window:

```
curl https://raw.githubusercontent.com/ccrisan/motioneyeos/master/writeimage.sh
chmod 775 writeimage.sh
```

**My Home Network**

Devices currently connected to your Plusnet Hub:

Network	Device	MAC Address	IP Address
2.4 GHz Wireless:	udhcp-1-18-5-18-5...	40:3d:ec:ca:d7:04	192.168.1.65
5 GHz Wireless:	alex-pc	04:e6:76:8e:d6:fd	192.168.1.68
	android-e859ee5d2...	14:dd:a9:48:b6:02	192.168.1.67
	Chromecast	54:60:09:07:9f:86	192.168.1.71
	android-8fe640c2a...	30:5a:3a:8f:a9:d9	192.168.1.77
	iPhone	a0:ed:cd:a8:ce:c5	192.168.1.69
	Philips-Mini-2	2c:f0:a2:f3:50:6a	192.168.1.75
	Philips-Mini	90:84:0d:f2:77:2f	192.168.1.70
Ethernet:	meye-20795faf	b8:27:eb:79:5f:af	<a href="#">192.168.1.86</a>
USB:	No devices detected		

🔗 Find the IP address of the motionEyeOS Pi by visiting your router's homepage

To write to the microSD card and preconfigure the wireless connection, use:

```
./writeimage.sh -d /dev/yoursdcard -i "/path/to/motioneyeos.img"
-n 'yournet:yourkey'
```

...replacing the generic elements with your own details.

## 02 Alternative wireless method

Another way of preconfiguring wireless connectivity, if you're using a standard card writing method, is to create a file called **wpa\_supplicant.conf** containing these lines (with your router's SSID and password):

```
update_config=1
ctrl_interface=/var/run/wpa_supplicant

network={
    scan_ssid=1
    ssid="your_network"
    psk="your_password"
}
```

You will need to turn the file into an executable with **chmod +x wpa\_supplicant.conf** before moving it to the boot partition of your microSD card (alongside **start.elf** etc.). Note: From version 20190119, WiFi configuration will be read every time the device boots.



▲ Intruder alert! Any change in the camera view will be detected, triggering stills or video capture

### 03 Remote access

Insert the microSD card into your Raspberry Pi and boot it. There is no need to attach it to a monitor as it won't show much and it's intended to be run headless. Assuming you've preconfigured the wireless connection, it should connect to the router after a couple of minutes. If you have any problems, check the wireless details you entered; if your router syncs 2.4GHz and 5GHz on the same SSID, you may need to split this into separate SSIDs to get a connection. If you're still having trouble, you can connect to the router via an Ethernet cable and set up a wireless connection from the remote web interface later.

Either way, to find Raspberry Pi's IP address, just visit your router's homepage (e.g. 192.168.1.254) and view the list of attached devices; your Raspberry Pi will appear as meye- followed by a hex number. Enter the IP address for it in a web browser on a remote computer. You will be presented with a login screen: just enter the default admin username without a password. You can add a password later, as well as a standard user.

### 04 Camera features

Once you're logged in, you will be able to see the live view from the camera, which you can also expand. Open the options menu on the left (the icon is three horizontal parallel lines) to access numerous options; change Layout Columns to 1 to enlarge the standard camera view.

Click the 'switch user' icon near the top left and enter the username 'admin' with no password to reveal a host of extra options. These include camera settings such as video resolution and rotation. You can also adjust motion detection settings and options for capturing stills and movies, which can be viewed via the icons shown on the camera view after you click on it. The Motion Notifications panel enables you to send yourself an email whenever motion is detected, or call a web hook, or run a command. This last option is what we'll be using for our custom notifications using the Pushover service.

## 05 Create Pushover app

Pushover has a great, easy-to-use API. You'll need a Pushover account – you can create one at [pushover.net](https://pushover.net). Note: after a seven-day free trial, you will need to pay a one-off fee of \$4.99 per platform (iOS, Android, Desktop) to continue receiving notifications for it from the Pushover service.

Once you've registered, go to the [pushover.net/apps](https://pushover.net/apps) page and click on 'Create a New Application / API Token'. Give your app a name – something like RaspiMotion. Give your app a quick description (e.g. 'Push notifications sent by my Raspberry Pi') and, if you are feeling creative, upload a custom icon which will show in your Pushover client app whenever a notification is sent. Finally, tick the Terms of Service checkbox and click 'Create Application'

Once you have created your application, you should have access to an API token/key. This is a unique combination of numbers and letters: keep it a secret! You'll also need your user key, which is shown once you log into Pushover's website. Now you have an app and your API and user keys. The next thing is to write a Python script to tell your Raspberry Pi to work its magic once the script is called upon by motionEyeOS.

## 06 Write Python script

You'll need to SSH into your Raspberry Pi from a Terminal window on a remote computer (or PuTTY on Windows) to do this, using `ssh admin@IP-address`. The default user is admin, with no password. Our script needs to live in the data folder, so go there and create `ch16listing1.py` using nano:

```
cd /data
nano ch16listing1.py
```

Once here, you'll need to type in the code listing, while also including your API token and user key where required. As with any script, we need to make sure it can be executed, otherwise it's nothing more than a fancy collection of text! From the command line, make sure you're in the data folder and then type:

```
chmod +x ch16listing1.py
```

Or, if you are using WinSCP, select the **ch16listing1.py** file in the data folder, then press **F9**. In the window that appears, change the permissions to 0755 and then click 'OK' to confirm.

## 07 Trigger the script

Now that we have our script, we need to tell motionEyeOS to use it when it detects motion. To do this, log in, go to the Motion Notifications menu and turn on the 'Run A Command' option. You then need to specify which command to run, which will be the Python script you just created – this is **/data/ch16listing1.py**. Then click on Apply to confirm the changes.

To test it out, you'll need the Pushover app installed on your smartphone or tablet. Wave your hand in front of your camera (or you can do a dance if you're feeling energetic!) and then shortly afterwards you should receive a notification via Pushover, warning you that motion has been detected. Feel free to experiment with the script to customise the message displayed and sound played in Pushover.

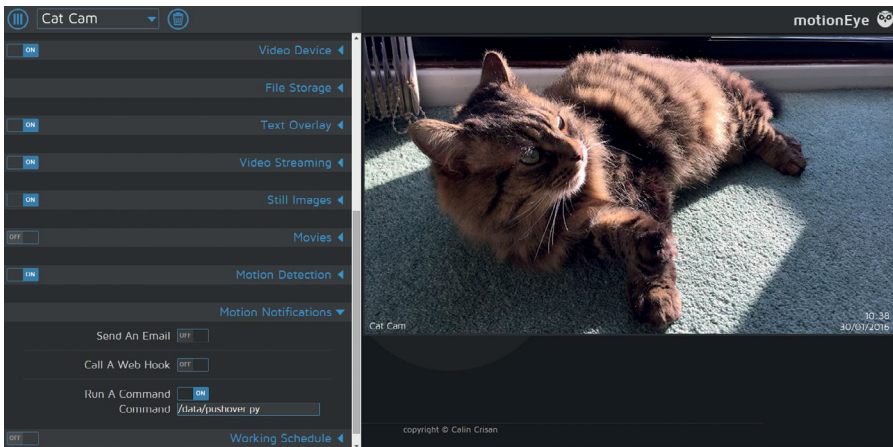

▣ In the Motion Notifications menu, set Run A Command to the path of your script

**ch16listing1.py** / Python 3 **DOWNLOAD**[magpi.cc/cameragit16](https://magpi.cc/cameragit16)

```
import httplib, urllib
```

```
conn = httplib.HTTPSConnection("api.pushover.net:443")
conn.request("POST", "/1/messages.json",
    urllib.urlencode({
        "token": "APP_TOKEN",
        # Insert app token here
        "user": "USER_TOKEN",
        # Insert user token here
        "html": "1",
        # 1 for HTML, 0 to disable
        "title": "Motion Detected!",
        # Title of the message
        "message": "<b>Front Door</b> camera!",
        # Content of the message
        "url": "http://IP.ADD.RE.SS",
        # Link to be included in message
        "url_title": "View live stream",
        # Text for the link
        "sound": "siren",
        # Define the sound played
    }), { "Content-type": "application/x-www-form-urlencoded" })
conn.getresponse()
```

## Chapter 17

# Quick reference

To help you get to grips with your HQ Camera or Camera Module, here's a handy reference guide to the hardware, commands, and picamera Python library

## 01. Camera hardware

Find out all about the HQ Camera and Camera Module hardware

**T**he first thing to note about the Raspberry Pi HQ Camera and Camera Module is that they both feature a rolling shutter. So, when capturing an image, the camera reads out the pixels from the sensor one row at a time. Unlike the global shutter on a DSLR camera, it also lacks a physical shutter that covers the sensor when not in use.

In addition, the HQ Camera or Camera Module acts more like a video camera than a stills camera, as it is rarely idle. Once initialised, it is constantly streaming rows of frames down the ribbon cable to Raspberry Pi for processing. Numerous background tasks include automatic gain control, exposure time, and white balance. That's why it's best to give it a couple of seconds or more once activated, to adjust the exposure levels and gains before capturing an image.

For more details on how the camera hardware works, see the picamera documentation at [magpi.cc/cameradoc](http://magpi.cc/cameradoc).

### FIXED FOCUS

Unlike the HQ Camera, the Camera Module has a fixed focal length of 50 cm and depth of field of 50 cm to infinity. This means that objects will only appear in focus if they're at least 50 cm away from the lens of the camera. However, it is possible to alter this by using a focus adjustment tool – or fine tweezers – to unscrew the lens slightly in order to shorten the focal length. See Chapter 14 Step 04 for more details.



## High Quality Camera

Compatible with any C- or CS-mount lens, the HQ Camera has the following key specs...

	High Quality Camera
<b>Sensor</b>	Sony IMX477
<b>Sensor resolution</b>	4056 × 3040 pixels (12.33MP)
<b>Image size</b>	Diagonal 7.857 mm (Type 1/2.3)
<b>Pixel size</b>	1.55 × 1.55 μm
<b>Image modes</b>	4056 × 3040 2028 × 1520 2028 × 1080 1012 × 760

## Camera Module versions

The original Camera Module features a 5MP Omnivision sensor, while the later v2 has an 8MP Sony IMX219. Here are the key specs for both...

	Camera Module v1	Camera Module v2
<b>Sensor</b>	Omnivision OV5647	Sony IMX219
<b>Sensor resolution</b>	2592 × 1944 pixels (5MP)	3280 × 2464 pixels (8MP)
<b>Sensor image area</b>	3.76 × 2.74 mm	3.69 × 2.81 mm
<b>Pixel size</b>	1.4 × 1.4 μm	1.12 × 1.12 μm
<b>Optical size</b>	1/4"	1/4"
<b>Video modes</b>	1920 × 1080, up to 30 fps 1280 × 720, up to 60 fps 640 × 480, up to 90 fps	1920 × 1080, up to 30 fps 1280 × 720, up to 60 fps 640 × 480, up to 90 fps

## Sensor input modes

By default, the camera switches automatically between sensor input modes according to parameters of the `raspistill` or `raspivid` command given. However, you can force the sensor into any of seven discrete modes (four for the HQ Camera), as detailed below, by using the `-md` switch (or `sensor_mode` constructor in picamera).

Note that you'll still need to specify the resolution and frame rate manually, which should be within the stated range. Modes with a partial field of view are captured from the centre of the sensor, as shown in **Figure 1** and **Figure 2** for Camera Module v1 and v2 respectively.

### HQ Camera

Mode	Resolution	Aspect Ratio	Frame rates	Video <sup>*</sup>	Image	FoV	Binning/Scaling
1	2028 × 1080	169:90	0.1-50 fps	○		Partial	2 × 2 binned
2	2028 × 1520	4:3	0.1-50 fps	○		Full	2 × 2 binned
3	4056 × 3040	4:3	0.005-10 fps	○	○	Full	None
4	1012 × 760	4:3	50.1-120 fps	○	○	Full	4 × 4 scaled

### Camera Module v1

Mode	Resolution	Aspect Ratio	Frame rates	Video <sup>*</sup>	Image	FoV	Binning/Scaling
1	1920 × 1080	16:9	1-30 fps	○		Partial	None
2	2592 × 1944	4:3	1-15 fps	○	○	Full	None
3	2592 × 1944	4:3	0.1666-1 fps	○	○	Full	None
4	1296 × 972	4:3	1-42 fps	○		Full	2 × 2 binned
5	1296 × 730	16:9	1-49 fps	○		Full	2 × 2 binned
6	640 × 480	4:3	42.1-60 fps	○		Full	4 × 4 scaled
7	640 × 480	4:3	60.1-90 fps	○		Full	4 × 4 scaled



## Camera Module v2

Mode	Resolution	Aspect Ratio	Frame rates	Video*	Image	FoV	Binning/Scaling
1	1920 × 1080	16:9	0.1-30 fps	○		Partial	None
2	3280 × 2464	4:3	0.1-15 fps	○	○	Full	None
3	3280 × 2464	4:3	0.1-15 fps	○	○	Full	None
4	1640 × 1232	4:3	0.1-40 fps	○		Full	2 × 2 binned
5	1640 × 922	16:9	0.1-40 fps	○		Full	2 × 2 binned
6	1280 × 720	16:9	40-90 fps	○		Partial	2 × 2 binned
7	640 × 480	4:3	40-90 fps	○		Partial	2 × 2 binned

\* Video recording is limited to a maximum 1080p (1920 × 1080) resolution on all camera models, regardless of the sensor mode used.

## 02. Command-line options

A guide to the options available when controlling the HQ Camera or Camera Module from the command line

### Common options

When using `raspistill` or `raspivid` from the command line, you have access to an array of useful switches to change numerous parameters....

#### Preview window settings

##### Preview position/size

`--preview` or `-p` (x,y,w,h)

Allows the user to define the size of the preview window (with `w` and `h` values) and its location on the screen (`x` and `y`). Note that this will be superimposed over the top of any other windows/graphics. For instance, to set its top-left corner at (100, 100) and give it dimensions of 300 × 200, use: `-p 100,100,300,200`.

---

##### Fullscreen preview mode

`--fullscreen` or `-f`

Forces the preview window to use the whole screen. Note that the aspect ratio of the incoming image will be retained, so there may be bars on some edges.

---

##### No preview window

`--nopreview` or `-n`

Disables the preview window completely. Note that even though the preview is disabled, the camera will still be producing frames, so it will be using power.

---

##### Preview opacity

`--opacity` or `-op`

Sets the opacity of the preview window; 0 = invisible, 255 = fully opaque.

#### Camera control options

##### Image width

`--width` or `-w`

Sets the width of the resulting image. Up to 2592 (Camera Module v1), 3820 (CM v2), 4056 (HQ Camera) – the upper limit for video footage is 1920.

### Image height

**--height** or **-h**

Sets the height of the resulting image. Up to 1944 (Camera Module v1), 2464 (CM v2), or 3040 (HQ Camera) – the upper limit for video footage is 1080.

---

### Image rotation

**--rotation** or **-rot** (0 to 359)

Sets the rotation of the preview and saved image. Note that only 0, 90, 180, and 270 degree rotations are supported (other values are rounded down).

---

### Horizontal flip

**--hflip** or **-hf**

Flips the preview and saved image horizontally.

---

### Vertical flip

**--vflip** or **-vf**

Flips the preview and saved image vertically. Note: Using **-hf** and **-vf** together is equivalent to a 180° rotation.

---

### Output to file

**--output** or **-o**

Specifies the output file name. If this is not specified, no file is saved. If the file name is '-', then all output is sent to stdout, which is handy when using another application that expects image or video data through a standard input.

---

### Timeout

**--timeout** or **-t**

The program will run for this length of time; the default is five seconds. If output is specified, it will then take a capture with **raspistill**. If using **raspivid**, this is the length of the recording.

---

### Verbose information

**--verbose** or **-v**

Outputs verbose debugging information during the run.

---

### Sharpness

**--sharpness** or **-sh** (-100 to 100)

Sets the sharpness of the image. 0 is the default.

---

### Contrast

**--contrast** or **-co** (-100 to 100)

Sets the contrast of the image. 0 is the default.

### Brightness

`--brightness` or `-br` (0 to 100)

Sets the brightness of the image. 50 is the default. 0 is black, 100 is white.

---

### Saturation

`--saturation` or `-sa` (-100 to 100)

Sets the colour saturation of the image. 0 is the default.

---

### ISO

`--ISO` or `-ISO` (100 to 800)

Sets the ISO to be used for captures. In effect, this adjusts the light sensitivity of the sensor.

---

### EV compensation

`--ev` or `-ev` (-10 to 10)

Sets the EV compensation of the image. Default is 0.

---

### Exposure mode

`--exposure` or `-ex`

Sets the exposure mode to any of: `auto`, `night`, `nightpreview`, `backlight`, `spotlight`, `sports`, `snow`, `beach`, `verylong` (long exposure), `fixedfps` (for video only), `antishake`, or `fireworks`. Not all of these settings may be implemented, depending on camera tuning.

---

### Automatic white balance (AWB)

`--awb` or `-awb`

Set the AWB mode to any of the following: `off`, `auto`, `sun`, `cloud`, `shade`, `tungsten`, `fluorescent`, `incandescent`, `flash`, or `horizon`.

---

### Image effect

`--imxfx` or `-ifx`

Sets an effect to be applied to the image. Choose from the following: `none`, `negative`, `solarise`, `posterise`, `sketch`, `denoise`, `emboss`, `oilpaint`, `hatch`, `gpen` (graphite sketch effect), `pastel`, `watercolour`, `film`, `blur`, `saturation` (colour saturate the image), `colourswap`, `washedout`, `colourpoint`, `colourbalance`, or `cartoon`.

---

### Colour effect

`--colfx` or `-cfx` (U:V)

The supplied U and V parameters (range 0 - 255) are applied to the U and V (colour) channels of the image. For example, `--colfx 128:128` will result in a monochrome image.

### Demo mode

`--demo` or `-d`

Cycles through the range of camera options. No capture is taken, and the demo will end at the end of the timeout period. The time between cycles should be specified in milliseconds.

---

### Metering mode

`--metering` or `-mm`

Specifies the metering mode used for the preview and capture. Choose from: `average`, `spot`, `backlit`, or `matrix`.

---

### Sensor region of interest

`--roi` or `-roi` (x,y,w,h)

Allows the specification of the area of the sensor to be used as the source for the preview and capture. This is defined as x,y for the top-left corner, and a width and height, with all values in normalised coordinates (0.0 to 1.0). So, to set a ROI at halfway across and down the sensor, and a width and height of a quarter of the sensor, use: `-roi 0.5,0.5,0.25,0.25`.

---

### Shutter speed

`--shutter` or `-ss`

Sets the shutter speed to the specified value (in microseconds). The upper limit is around 6000000  $\mu$ s (6 s) for CM v1; 10000000  $\mu$ s (10 s) for CM v2; 200000000  $\mu$ s (200s) for HQ Camera.

---

### Dynamic range compression (DRC)

`--drc` or `-drc`

DRC changes images by increasing the range of dark areas, while decreasing the brighter areas. This can improve the image in low light settings. Choose from: `off` (default), `low`, `medium`, or `high`.

---

### Image statistics

`--stats` or `-st`

This displays the exposure, analogue and digital gains, and AWB settings used.

---

### AWB gains

`--awbgains` or `-awbg`

Sets red and blue gains (as floating point numbers) to be applied when `-awb off` is set. For instance, `-awbg 1.5,1.2`.

---

### Sensor input mode

`--mode` or `-md`

Sets a specified sensor mode, disabling the automatic selection. See 'Camera Hardware' section for more details.

## Annotate flags/text

`--annotate` or `-a`

Adds some text and/or metadata to the image. Metadata is indicated using a bitmask notation, so add them together to show multiple parameters. For example, 12 will show `time(4)` and `date(8)`, since  $4+8=12$ . Text may include date/time placeholders by using the `'%'` character, as used by `strftime` ([magpi.cc/strftimedoc](http://magpi.cc/strftimedoc)).

Value	Meaning	Example Output
<code>-a 4</code>	Time	20:09:33
<code>-a 8</code>	Date	02/14/17
<code>-a 12</code>	4+8=12 Show the date(4) and time(8)	20:09:33 10/28/15
<code>-a 16</code>	Shutter Settings	
<code>-a 32</code>	CAF Settings	
<code>-a 64</code>	Gain Settings	
<code>-a 128</code>	Lens Settings	
<code>-a 256</code>	Motion Settings	
<code>-a 512</code>	Frame Number	
<code>-a 1024</code>	Black Background	
<code>-a "ABC"</code>	Show some text	ABC
<code>-a 4 -a "ABC %Y-%m-%d %X"</code>	Show custom formatted date/time	ABC 2017-02-17 20:09:33
<code>-a 8 -a "ABC %Y-%m-%d %X"</code>	Show custom formatted date/time	ABC 2017-02-17 20:09:33



### Extra annotation parameters

`--annotateex` or `-ae`

Specifies annotation size, text colour, and background colour. Colours are in hex YUV format. Size ranges from 6 to 160; default is 32. Asking for an invalid size should give you the default.

Examples:

```
-ae 32,0xff,0x808000 -a "Text" gives size 32 white text on black background.
```

```
-ae 10,0x00,0x8080FF -a "Text" gives size 10 black text on white background.
```

## TWO CAMERAS

Since the Raspberry Pi has only one CSI connector for a camera, the use of two cameras is only possible with a Compute Module (see [magpi.cc/cmtwocameras](http://magpi.cc/cmtwocameras)). In this case, the following commands may be used for stereoscopic images and video.

`--camselect` or `-cs` – Selects which camera to use. Use 0 or 1.

`--stereo` or `-3d` – Selects stereoscopic mode.

`--decimate` or `-dec` – Half width/height of stereo image.

`--3dswap` or `-3dswap` – Swaps camera order for stereoscopic.

## Photo options

The following options are only available when using the `raspistill` command (and most of them also when using `raspiyuv`).

### Time-lapse mode

`--timelapse` or `-t1`

The specific value is the time between shots in milliseconds. Note that you should specify `%04d` at the point in the file name where you want a frame count number to appear. So, for example, the following code will produce a capture every two seconds, over a total period of 30 seconds, named `image0001.jpg`, `image0002.jpg` and so on, through to `image0015.jpg`:

```
-t 30000 -t1 2000 -o image%04d.jpg
```

If a time-lapse value of 0 is entered, the application will take pictures as fast as possible. Note that there's a minimum enforced pause of 30 ms between captures to ensure that exposure calculations can be made.

### Image quality

`--quality` or `-q`

Sets JPEG quality, from 0 to 100.

---

### Raw data

`--raw` or `-r`

Adds raw Bayer data to JPEG metadata.

---

### Link latest frame

`--latest` or `-l`

Links latest frame to file name specified.

---

### Thumbnail parameters

`--thumb` or `-th` (x:y:quality)

Allows specification of the thumbnail image inserted into the JPEG file. If not specified, defaults are a size of 64×48 at quality 35. If `--thumb none` is specified, no thumbnail information will be placed in the file; this reduces the file size slightly.

---

### Encoding for output file

`--encoding` or `-e`

Valid options are jpg, bmp, gif, and png. Note that unaccelerated image types (GIF, PNG, BMP) will take much longer to save than JPG, which is hardware accelerated. Also, the file name suffix is completely ignored when deciding the encoding of a file.

---

### EXIF tag

`--exif` or `-x` (format as 'key=value')

Allows the insertion of specific EXIF tags into the JPEG image. You can have up to 32 EXIF tag entries. This is useful for tasks like adding GPS metadata. For example, to set the longitude to 5 degrees, 10 minutes, 15 seconds, use:

```
--exif GPS.GPSLongitude=5/1,10/1,15/1
```

See EXIF documentation for more details on the range of tags. Setting `--exif none` will prevent any EXIF information being stored in the file; this reduces the file size slightly.

---

### Full preview mode

`--fullpreview` or `-fp`

Runs the preview window using the full-resolution capture mode. Maximum frame rate in this mode is 15 fps, and the preview will have the same field of view as the capture. Captures should happen more quickly, as no mode change is required.

### Keypress mode

`--keypress` or `-k`

The camera is run for the requested time (`-t`), and a capture can be initiated throughout that time by pressing the **ENTER** key. If you are using `raspivid`, this will pause or resume shooting video.

Pressing **X** then **ENTER** will exit the application before the timeout is reached. If the timeout is set to 0, the camera will run indefinitely until exited.

With `raspivid`, the timeout value will be used to signal the end of recording, but is only checked after each **ENTER** keypress.

---

### Signal mode

`--signal` or `-s`

The camera is run for the requested time (`-t`), and a capture can be initiated throughout that time by sending a USR1 signal to the camera process; or, with `raspivid`, it toggles between paused and recording. This can be done using the `kill` command:

```
kill -USR1 <process id of raspistill or raspivid>
```

To find the camera process ID, use `grep raspistill` or `pgrep raspivid`.

---

### Burst mode

`--burst` or `-bm`

Enables burst capture mode, to capture a sequence of images (using time-lapse, `-tl`) without switching back to preview mode between them. This helps to prevent dropped frames when using a short delay.

## RASPIYUV OPTIONS

The `raspiyuv` command uses most of the same options as `raspistill`. Unsupported ones are `--exif`, `--encoding`, `--thumb`, `--raw`, and `-quality`.

One extra option is `--rgb` or `-rgb`. This forces the image to be saved as RGB data with 8 bits per channel, rather than YUV420.

Note that the image buffers saved in `raspiyuv` are padded to a horizontal size divisible by 32, so there may be unused bytes at the end of each line. Buffers are also padded vertically to be divisible by 16, and in the YUV mode, each plane of Y,U,V is padded in this way.

## Video options

The following options are specific to the `raspivid` command for shooting video.

### Bitrate

`--bitrate` or `-b`

Sets the bitrate for the video. Use bits per second, so 10Mbps/s would be `-b 10000000`. For H.264, 1080p30 a high-quality bitrate would be 15Mbps/s or more. Maximum bitrate is 25Mbps/s (`-b 25000000`), but much over 17Mbps/s won't show noticeable improvement at 1080p30.

---

### Frame rate

`--framerate` or `-fps`

Specifies the frames per second to record. This varies depending on the camera mode used. The maximum is 90 fps, when using a resolution of 640 × 480. See the Camera Hardware section for more details.

---

### Video stabilisation

`--vstab` or `-vs`

Turns on video stabilisation, which attempts to account for camera shake when it is moving.

---

### Preview after encoding

`--penc` or `-e`

Displays the preview after compression, to show any artefacts. In normal operation, the preview will show the camera output prior to being compressed.

---

### Intra refresh period

`--intra` or `-g`

Sets the intra refresh period (GoP) rate for the recorded video. H.264 video uses a complete frame (I-frame) every intra refresh period, from which subsequent frames are based. This option specifies the number of frames between each I-frame. Larger numbers here will reduce the size of the resulting video, while smaller numbers make the stream less error-prone.

---

### Quantisation

`--qp` or `-qp`

Sets the initial quantisation parameter for the stream. Varies from approximately 10 to 40, and will greatly affect the quality of the recording. Higher values reduce quality and decrease file size. Combine this setting with a bitrate of 0 to set a completely variable bitrate.

---

### H.264 profile

`--profile` or `-pf`

Sets the H.264 profile to be used for the encoding. Options are: `baseline`, `main`, or `high`.

### Insert PPS & SPS headers

`--inline` or `-ih`

Forces the stream to include PPS and SPS headers on every I-frame. Needed for certain streaming cases, e.g. Apple HLS.

---

### Timed pause/record periods

`--timed` or `-td`

Allows video capture to be paused and restarted at specified time intervals. Two values are required: the on time (for recording) and the off time (for paused). The total time of the recording is defined by the timeout option. For example:

```
raspivid -o test.h264 -t 25000 -timed 2500,5000
```

...will record for a period of 25 seconds. The recording will be over a time frame consisting of 2500 ms (2.5 s) segments with 5000 ms (5 s) gaps, repeating over the 20 s. So the entire recording will actually be only ten seconds long.

---

### Initial state on startup

`--initial` or `-i`

Defines whether the camera will start paused or will immediately start recording (when using the `-td` option). Options are `record` or `pause`.

---

### Segment stream

`--segment` or `-sg`

Rather than creating a single file, the file is split into segments of approximately the number of milliseconds specified. In order to provide different file names, you should add `%04d` or similar at the point in the file name where you want a segment count number to appear. For example:

```
--segment 3000 -o video%04d.h264
```

...will produce video clips of approximately 3000 ms (3 s) long, named `video0001.h264`, `video0002.h264` etc.

---

### Maximum segment number

`--wrap` or `-wr`

When outputting segments, this sets the maximum the segment number can reach before it's reset to 1, giving the ability to keep recording segments, but overwriting the oldest one. So, if set to 4 in the previous segment example, the files produced will be `video0001.h264`, `video0002.h264`, `video0003.h264`, and `video0004.h264`. Once `video0004.h264` is recorded, the count will reset to 1, and `video0001.h264` will be overwritten.

### Initial segment number

`--start` or `-sn`

When outputting segments, this is the initial segment number, giving the ability to resume a previous recording from a given segment. The default value is 1.

---

### Circular buffer

`--circular` or `-c`

Runs encoded data through circular buffer until triggered, then saves.

---

### Inline motion vectors

`--vectors` or `-x`

Outputs inline motion vectors when used with `-o`.

---

### Intra refresh type

`--irefresh` or `-if`

Sets intra refresh type: `cyclic`, `adaptive`, `both`, or `cyclicrows`.

---

### Flush buffers

`--flush` or `-fl`

Flushes buffers in order to decrease latency.

---

### Timestamps

`--save-pts` or `-pts`

Saves timestamps to file for `mkvmerge`.

---

### Codec

`--codec` or `-cd`

Specifies the codec to use: H264 (default) or MJPEG.

---

### H.264 level

`--level` or `-lev`

Specifies H.264 level to use for encoding: 4, 4.1, or 4.2.

---

### Raw video

`--raw` or `-r`

Outputs raw video to file when used with `-o`.

---

### Raw format

`--raw-format` or `-rf`

Specifies output format for raw video: `yuv`, `rgb`, or `gray`.

## 03. Picamera Python library

Control the Camera Module from Python programs using the picamera library

### PiCamera class

Here are some of the most commonly used methods and options of the PiCamera class.

#### `start_preview(**options)`

Displays the preview overlay. Options include `fullscreen` (True or False), `window` (x,y,w,h for position and size), `layer`, and `alpha`.

---

#### `stop_preview()`

Hides the preview overlay.

---

#### `capture(output, format=None, use_video_port=False, resize=None, splitter_port=0, bayer=False, **options)`

Captures an image from the camera and stores it in `output`. If the latter is a string, it's treated as the name of a file; if an object, it's treated as a file-like object and the image data is appended to it.

---

#### `start_recording(output, format=None, resize=None, splitter_port=1, **options)`

Starts recording video from the camera, storing it in `output`. If the latter is a string, it's treated as the name of a file; if an object, it's treated as a file-like object and the video data is appended to it.

---

#### `wait_recording(timeout=0, splitter_port=1)`

Pauses recording for the number of seconds specified in `timeout`. This method is recommended over the standard `time.sleep()`, since it checks for errors during recording and will immediately raise an exception.

---

#### `stop_recording(splitter_port=1)`

Stops recording video from the camera. The optional `splitter_port` parameter specifies which port of the video splitter the encoder you wish to stop is attached to. Valid values are 0 to 3 (default 1).

### `close()`

Stops all recording and preview activities and releases all resources associated with the camera; this is necessary to prevent GPU memory leaks. It should always be called once you are finished with the camera (e.g. in the finally section of a try...finally block).

---

### `capture_continuous(output, format=None, use_video_port=False, resize=None, splitter_port=0, burst=False, bayer=False, **options)`

Captures images continuously from the camera as an infinite iterator. If `output` is a string, each image is stored in a file named after it with the substitution of two values: (`counter`) (a simple incrementer starting at 1) or (`timestamp`). For example, setting `output` to `'image(counter).jpg'` would result in `image1.jpg`, `image2.jpg`, `image3.jpg`, etc.

---

### `capture_sequence(outputs, format='jpeg', use_video_port=False, resize=None, splitter_port=0, burst=False, bayer=False, **options)`

Captures a sequence of consecutive images from the camera, as fast as is possible.

---

### `record_sequence(outputs, format='h264', resize=None, splitter_port=1, **options)`

Records a sequence of video clips from the camera. The caller can control how long to record to each item by only permitting the loop to continue when ready to switch to the next output.

---

### `split_recording(output, splitter_port=1, **options)`

Continues the recording in the specified output. When called, the video encoder will wait for the next appropriate split point (an inline SPS header), then will cease writing to the current output (and close it, if it was specified as a file name), and continue writing to the newly specified output.

---

### `add_overlay(source, size=None, **options)`

Adds a static overlay to the preview output.

---

### `remove_overlay(overlay)`

Removes a static overlay from the preview output. The `overlay` parameter specifies the `PiRenderer` instance that was returned by `add_overlay()`.

---

### `request_key_frame(splitter_port=1)`

Requests the encoder, running on the specified `splitter_port`, to generate a key-frame (full-image frame) as soon as possible.

---

### `analog_gain`

Retrieves the current analogue gain of the camera.



**annotate\_text**

Retrieves or sets a text annotation for all output.

---

**awb\_gains**

Gets or sets the auto-white-balance gains of the camera, as a tuple (red, blue) – values are between 0.0 and 8.0. This attribute only has an effect when **awb\_mode** is set to 'off'.

---

**awb\_mode**

Retrieves or sets the auto-white-balance mode of the camera. Possible values are: 'off', 'auto' (default), 'sunlight', 'cloudy', 'shade', 'tungsten', 'fluorescent', 'incandescent', 'flash', or 'horizon'.

---

**brightness**

Retrieves or sets the brightness setting of the camera, as an integer between 0 and 100 (default 50).

---

**color\_effects**

Retrieves or sets the current colour effect applied by the camera, as a (u, v) tuple – values are between 0 and 255. When set to (128, 128), it results in a black and white image.

---

**contrast**

Retrieves or sets the contrast setting of the camera, as an integer between -100 and 100 (default 0).

---

**digital\_gain**

Retrieves the current digital gain of the camera.

---

**drc\_strength**

Retrieves or sets the dynamic range compression strength of the camera. Valid values are: 'off' (default), 'low', 'medium', or 'high'.

---

**exposure\_compensation**

Retrieves or sets the exposure compensation level of the camera, as an integer between -25 and 25 (default 0). Each increment represents 1/6th of a stop.

---

**exposure\_mode**

Retrieves or sets the exposure mode of the camera. Valid values are: 'off', 'auto' (default), 'night', 'nightpreview', 'backlight', 'spotlight', 'sports', 'snow', 'beach', 'verylong', 'fixedfps', 'antishake', or 'fireworks'.

### **exposure\_speed**

Retrieves the current shutter speed of the camera, in microseconds. The default is 0 (auto).

---

### **flash\_mode**

Retrieves or sets the flash mode of the camera. Valid values are: 'off' (default), 'auto', 'on', 'redeye', 'fillin', or 'torch'.

*Note: You must define which GPIO pin the camera is to use for flash (and optional privacy indicator). This is done within the device tree configuration, as detailed in Chapter 7.*

---

### **frame**

Retrieves information about the current frame recorded from the camera.

---

### **framerate**

Retrieves or sets the frame rate at which video-port based image captures, video recordings, and previews will run. It can be specified as an int, float, or fraction. The default is 30.

*Note: The actual sensor frame rate and resolution used by the camera is influenced – but not directly set – by this property.*

---

### **hflip**

Retrieves or sets whether the camera's output is horizontally flipped. Default is False.

---

### **image\_denoise**

Retrieves or sets whether denoise will be applied to image captures. Default is True.

---

### **image\_effect**

Retrieves or sets the current image effect applied by the camera. Valid values are: 'none' (default), 'negative', 'solarize', 'sketch', 'denoise', 'emboss', 'oilpaint', 'hatch', 'gpen', 'pastel', 'watercolor', 'film', 'blur', 'saturation', 'colorswap', 'washedout', 'posterise', 'colorpoint', 'colorbalance', 'cartoon', 'deinterlace1', or 'deinterlace2'.

---

### **image\_effect\_params**

Retrieves or sets the parameters for the current effect, as a tuple of numeric values up to six elements long.

---

### **iso**

Retrieves or sets the apparent ISO setting of the camera, which represents its sensitivity to light. Lower values tend to produce less 'noisy' images, but operate poorly in low light conditions. Valid values are: 0 (auto), 100, 200, 320, 400, 500, 640, or 800.

**led**

Sets the state of the camera's LED (CM v1 only) via GPIO. If the RPi.GPIO library is available and the Python process is run as root via sudo, this property can be used to set the state of the camera's LED as a Boolean value (True is on, False is off).

*Note: This doesn't work on the Raspberry Pi 3 or 4, due to a GPIO reconfiguration.*

---

**meter\_mode**

Retrieves or sets the metering mode of the camera. Valid values are: **'average'** (default), **'spot'**, **'backlit'**, **'matrix'**.

---

**recording**

Returns True if the **start\_recording()** method has been called, and no **stop\_recording()** call has been made yet.

---

**resolution**

Retrieves or sets the resolution at which image captures, video recordings, and previews will be captured. It can be specified as a (width, height) tuple, a string formatted 'WIDTHxHEIGHT', or as a string containing a commonly recognized display resolution name (e.g. 'VGA', 'HD', '1080p', etc). The camera must not be closed, and no recording must be active when the property is set.

---

**rotation**

Retrieves or sets the current rotation of the camera's image. Valid values are: 0 (default), 90, 180, and 270.

---

**saturation**

Retrieves or sets the saturation setting of the camera, as an integer between -100 and 100 (default 0).

---

**sensor\_mode**

Retrieves or sets the input mode of the camera's sensor. By default, mode 0 is used, which allows the camera to automatically select an input mode based on the requested resolution and frame rate. Valid values are currently between 0 and 7. See the Camera Hardware section for more details on modes.

---

**sharpness**

Retrieves or sets the sharpness setting of the camera as an integer between -100 and 100 (default 0).

### **shutter\_speed**

Retrieves or sets the shutter speed of the camera in microseconds. Default is 0 (auto). Faster shutter times require greater amounts of illumination and vice versa.

*Note: In later firmwares, this attribute is limited by the value of the **framerate** attribute. For example, if it's set to 30fps, the shutter speed cannot be slower than 33,333  $\mu$ s.*

---

### **timestamp**

Retrieves the system time according to the camera firmware.

---

### **vflip**

Retrieves or sets whether the camera's output is vertically flipped. The default value is False.

---

### **video\_denoise**

Retrieves or sets whether denoise will be applied to video recordings. The default value is True.

---

### **video\_stabilization**

Retrieves or sets the video stabilisation mode of the camera. The default value is False.

*Note: The built-in video stabilisation only accounts for vertical and horizontal motion, not rotation.*

---

### **zoom**

Retrieves or sets the zoom applied to the camera's input, as a tuple (x, y, w, h) of floating point values ranging from 0.0 to 1.0, indicating the proportion of the image to include in the output (the 'region of interest'). The default value is (0.0, 0.0, 1.0, 1.0), which indicates that everything should be included.



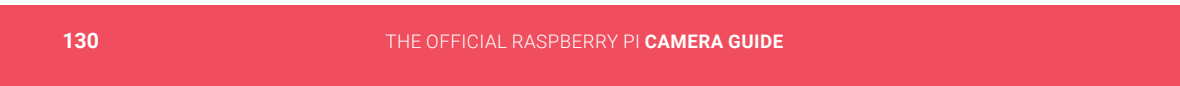



## **Take pictures and shoot video with your Raspberry Pi.**

Connecting the official High Quality Camera or Camera Module turns your favourite credit-card-sized computer into a powerful digital camera. Learn how to set up and control the camera to capture stills and video footage. Discover the numerous modes and effects available, and use the camera in a variety of exciting projects across 17 packed chapters:

- 
- **Precise camera control**
  - **Time-lapse photography**
  - **Selfies and stop-motion video**
  - **Build a wildlife camera**
  - **Make a video doorbell**
  - **Live-stream video and stills**
  - **Set up a security camera**
- & much more!**